

**Pellet Condensing Boiler**  
ETA *e*PE BW 8-62 kW



... my heating system



State-of-the-art condensing technology  
for new builds and renovations

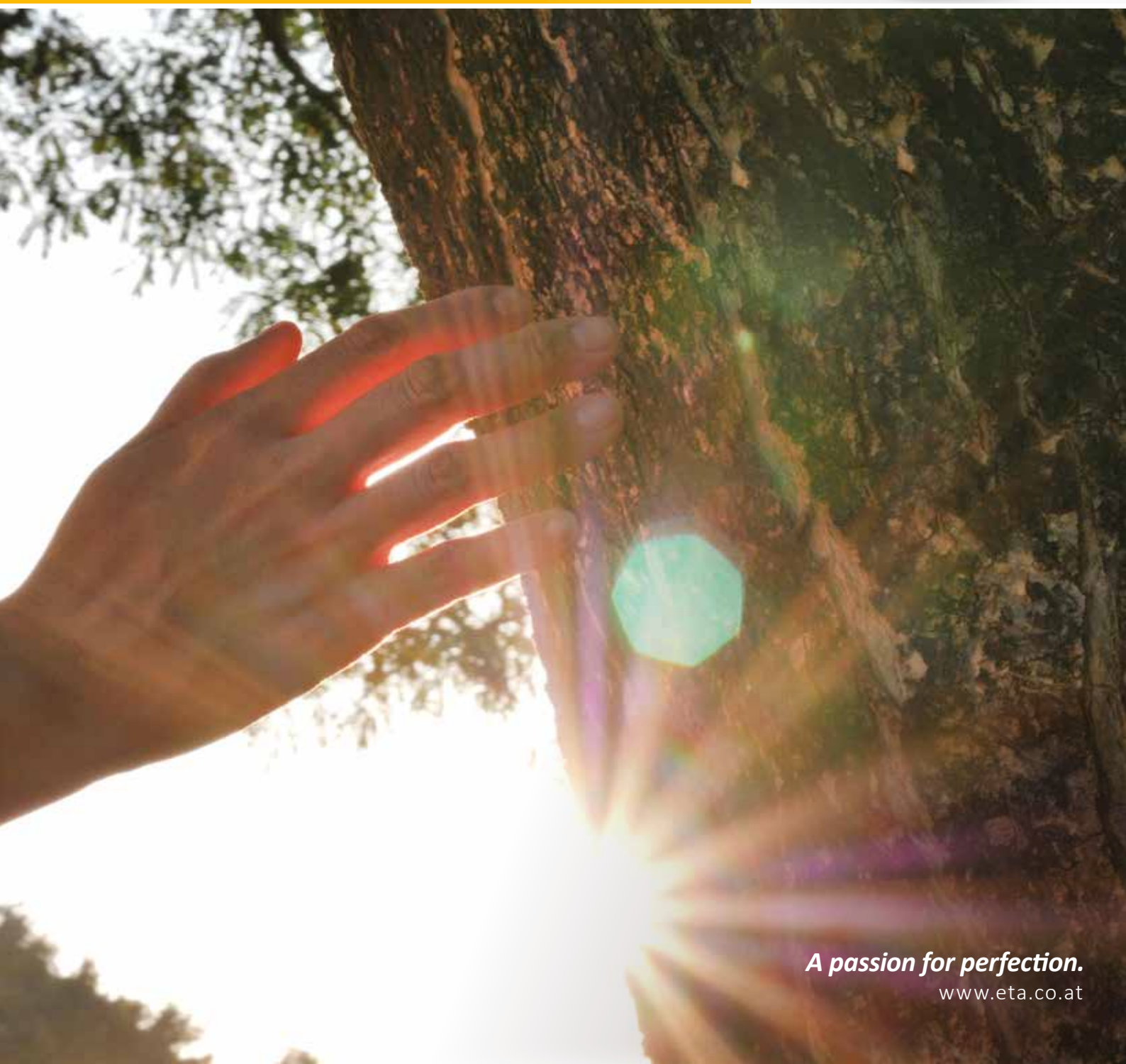
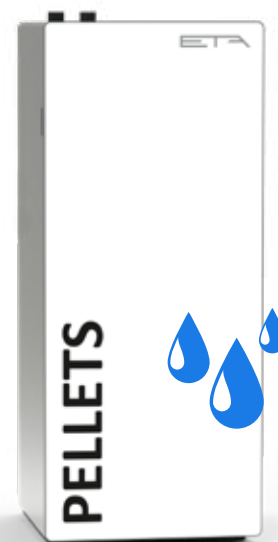

*A passion for perfection.*

[www.eta.co.at](http://www.eta.co.at)



## No one is smaller

With a footprint of less than 0.5 m<sup>2</sup>, the ETA ePE BW is the smallest high-tech pellet boiler with condensing technology, integrated hydraulics and precipitator on the market. And because the connections are flexible, it can be installed almost anywhere.

The ETA ePE BW is the ideal pellet boiler for refurbishment when using underfloor or wall heating or for new constructions of single family housing and apartment buildings. The entire heating system is packed into a compact boiler. High efficiency pump, safety devices and more are already integrated. This not only reduces the space needed, but also the assembly costs. And the operating costs drop too. This is ensured by state-of-the-art boiler technology and, in this model, also by the integrated condensing heat exchanger. It also uses the waste heat for heating and thus further increases efficiency. And the ETA ePE BW is also flexible: even a second heating circuit can be integrated!

### Can be set-up anywhere

If necessary, the ETA ePE BW extracts the oxygen required for combustion from the outside. Thanks to this operation with external air supply, the boiler may be placed not only in ventilated boiler rooms, but also in heated buildings or in rooms with comfort ventilation. Placement in the living room is also no problem visually: the ETA ePE BW looks so good that people like to show it off.

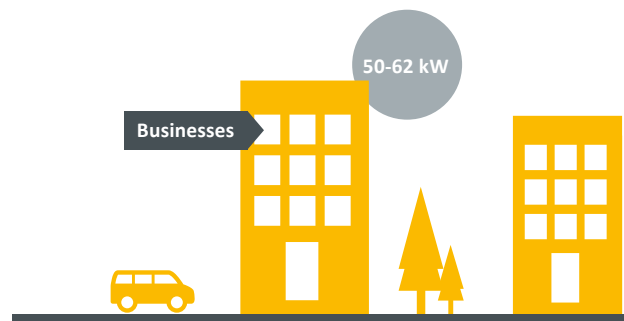

### Wooden briquettes for maximum comfort

Pellets are balls of energy made from compressed wood by-products. Those who use the small and powerful briquettes heat fully automatically and at the highest level of convenience. Only the ash bin needs to be emptied every now and again. The pellet store room can be up to 20 metres away from the heating boiler and needs no more space than the room of an oil tank. The ETA ePE BW is also ideal for all heating refurbishers who want to protect the climate and reduce operating costs.

# A win-win situation

Save heating costs, boost your domestic economy and help the environment in the process: heating with pellets pays off. Currently, around 7 million cubic metres of excess wood is growing in Austria - and forested areas are increasing across the whole of Europe.

## Using resources sensibly

In contrast to fuels such as oil and gas, pellets hardly effect the climate. That is because trees absorb as much CO<sub>2</sub> during growth as they later release during combustion. In addition, the CO<sub>2</sub> released when burning is equal to or less than that of naturally rotting wood.

about 30 kg **CO<sub>2</sub>** are emitted when you

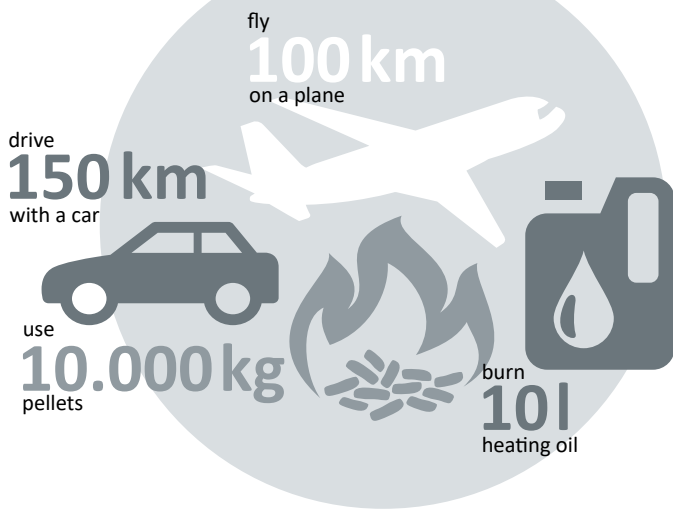

## Wood cutting in the sawmill

100% softwood\* (without bark) consisting of:

Sawn timber (60%)

Sawmill by-products (40%)

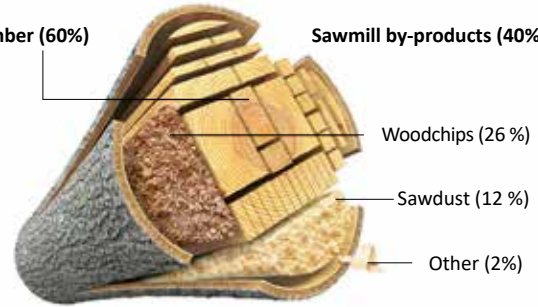

\*More than 95% of sawmill products in German sawmills are made of softwood.  
Source: Döring, P.; Mantau, U: Standorte der Holzwirtschaft - Sägeindustrie - Einschnitt und Sägenebenprodukte 2010. Hamburg, 2012.  
Conversion: DEPI. German Pellet Institute, using images from mipan / 123RF.com and Can Stock Photo / dusan694

*No extra trees have to be felled to produce pellets, because the wooden briquettes consist mainly of sawdust, a waste product of the wood industry.*

## Price development of energy sources

for households 2004 - 2024

Cent/kWh

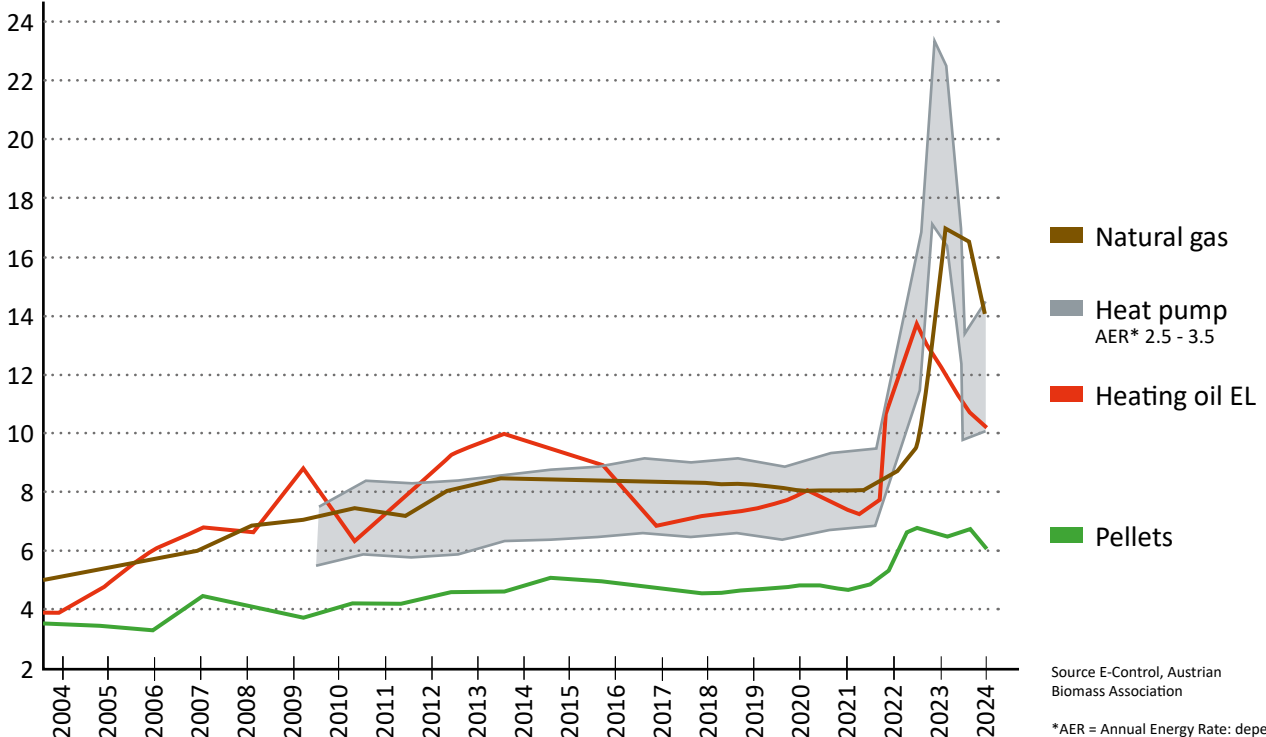

Source E-Control, Austrian Biomass Association

\*AER = Annual Energy Rate: depending on the existing building

# Always space for pellets

The pellet store can easily be set up anywhere an oil tank has previously stood. It doesn't even have to be near the boiler, but can be located up to 20 m away. If the pellet store is located beneath the boiler, and if using a suitable conveying system, up to two storeys can be overcome. If there's no space in the house, the store room can also be set up in an adjacent building or an underground tank can be used. The store room just needs to be dry so that the pellets don't swell up. Wooden cladding can help in rather damp rooms.

## A clean solution

The pellets, which are created from the compacted waste products of the wood industry, are delivered by tanker lorry and blown into the store room. So the delivery of pellets is an extremely clean and easy process. If the store is sealed, no dust can escape here either.

Attractive also for complete renovations and new builds: with a well insulated house, 6 m<sup>2</sup> is often sufficient for the heating and pellet storage room.



## How big does my store room have to be?

The approximate pellet requirement per year in tonnes is calculated by dividing the heating load in kilowatts by 3. To calculate the pellet requirement in cubic metres, divide the heating load by 2. So, for example, for 30 kW heating load you need approx. 15 m<sup>3</sup> or 10 tonnes pellets per year. When moving from another energy source, the pellet requirement can also be determined from the previous consumption.

1 ton of pellets roughly corresponds to:

- 500 l heating oil
- 520 m<sup>3</sup> natural gas
- 750 l liquid gas
- 600 kg coke (fuel)
- 1,400 kWh power with geothermal energy pumps (coefficient of performance 3.4)
- 2,000 kWh power with air heat pumps (coefficient of performance 2.5)

## How do the pellets get to the boiler?

**Discharge screw:** It stretches the entire length of the store room, can be up to 6 m long and transports the pellets from the store room to the transport hoses, which lead to the boiler. From here, the pellets are conveyed further. After transport the hoses are vacuumed empty. Hence they do not clog up and always work with the highest degree of efficiency. With this standard system, the store room can be completely emptied.

Over the inclined smooth floor, the pellets automatically slide to the transport screw. The impact protection mat is suspended opposite the filling nozzles, so that the pellets do not shatter on the wall when they are blown into the store room from the truck. The prerequisite for this construction is that the connections for the transport hoses to the boiler are located on the narrow side of the store room, so that the whole length of the room can be used with the screw.

Back air and filling nozzles

Impact protection mat

Return and suction hose

With the ETA System, pellet transport goes particularly quickly - the suction times are very short.

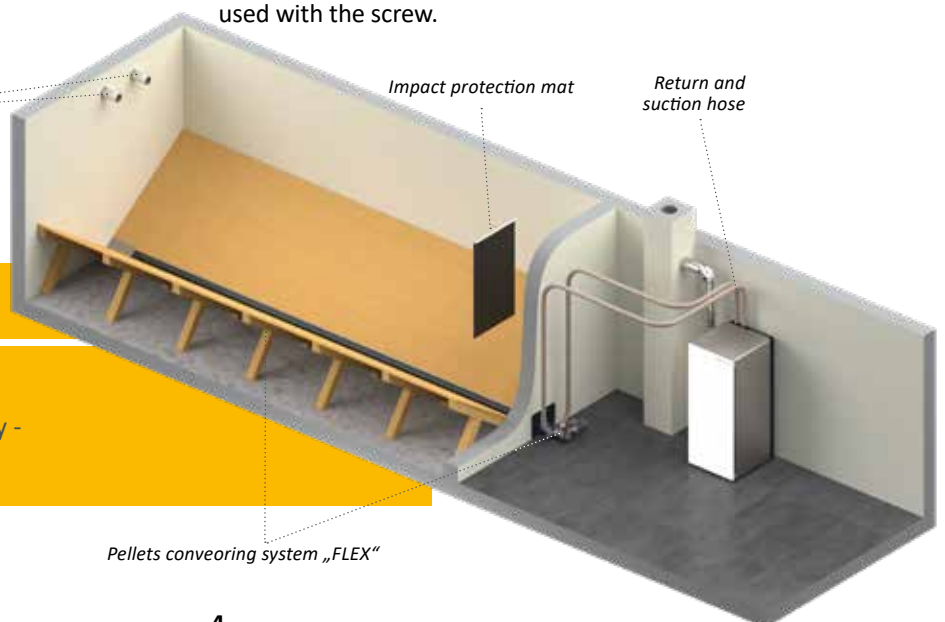

Pellets conveying system „FLEX“



**Suction probes:**

If the shape of the room is not suitable for a discharge screw, the ETA switching unit system is the ideal choice. Here, the pellets slide over the slanting and smooth wooden floor directly to the four suction probes, which alternately transport pellets away from the store room. Through automatic changeover, the fuel supply is not interrupted if a probe doesn't get any pellets at a certain

point in time. The prerequisite for this system is that the store room is situated opposite the boiler in the same storey or higher, and that the store room is no longer than 4 m. Unlike screws, the suction probes do not fully empty the store room. When the storage room capacity is tight, this can be a disadvantage. The advantage is that this system can be used even in angled store rooms.

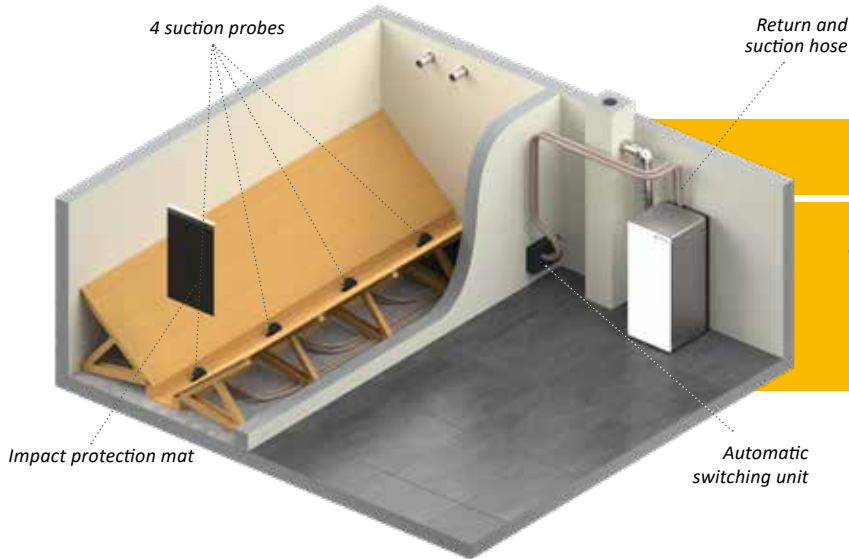

With the suction probes, nearly any room can be used as a pellet store, even if the store room is angular.

**Mole conveying system:**

Due to the structural constraints, conventional ETA pellet conveying systems may have some limitations in terms of usable pellet storage volume. The high quality E3 mole conveying system is a useful application in this situation.

**ETA tip: storage in the ETA Box**

One particularly practical solution is the ETAbox. It can be set up in the boiler room, in an attic, in a barn or – if covered – even outside. It even keeps the pellets dry in damp rooms. Distances of up to 20 metres of suction hose stretching from the box to the boiler are no problem. Please note that the ETAbox cannot be set up directly on a wall. This is why the space required is a bit larger compared to a brick store with the same capacity.

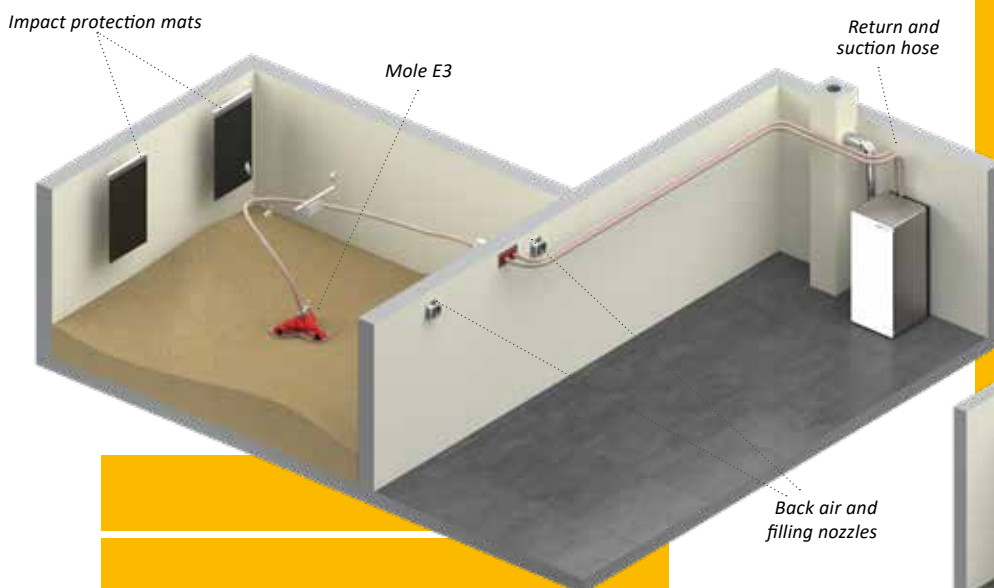

With the E3 mole conveying system, the storage space can be almost completely emptied and the sloping wooden structure is eliminated.



## Heat, just the way you need it

The ETA ePE BW doesn't just produce heat, the ETA System also distributes it efficiently. Rely on the perfect control centre for your heating and hot water system.

The ETA ePE BW is equipped with a control system for the entire heating system. Whether you want to integrate a solar heating system, a conventional domestic hot water preparation system or a buffer storage tank with fresh water module, whether the energy is transferred with radiators or via floor or wall heating: everything is controlled from a touchscreen on the boiler or via a computer or smartphone. Simple images show you if your solar heating system was operating or how full your buffer is.

### With buffer, please

Of course the ETA ePE BW can work by itself. However the ETA buffer storage tank is its perfect partner. Above all, when heating in autumn or in spring and for hot water preparation in the summer, often less energy is needed than the boiler

*No matter whether you want to integrate a solar heating system, a domestic hot water preparation system or a buffer storage tank with a fresh water module: the whole system can easily be controlled from a touch screen on the boiler.*

Remote controlled via the meinETA communication platform



produces. The buffer stores this excess heat and releases it on demand. This saves fuel and protects the boiler, because fewer boiler starts are needed.

The ETA stratified buffer is ideal for the integration of a solar heating system. In summer, hot water can be produced at virtually no operating costs. But in winter, the solar collectors seldom produce the 60 °C that are common for domestic hot water preparation. Then the water that is heated by solar energy is fed through the underfloor or wall heating. This usually works with hot water temperatures of just 30 to 40 °C.







**Everything at a glance!**  
The ETA room sensor displays the room temperature and the outside temperature and enables a simple change of the desired room temperature.

ETA individual room temperature control. A pleasant temperature, one room at a time

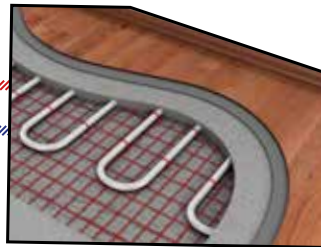

*ePE-BW 8-22: direct connection of an (optional) integrated heating circuit without external pumps in the boiler room*

*The ETA stratified buffer can also be equipped with a fresh water module, which constantly reheats the tap water with the help of a heat exchanger. This ensures that the risk of germs and bacteria is minimised.*



*An ETA stratified buffer is the ideal addition to a ePE BW. It stores energy that is not required and delivers it on demand.*



## Safe, reliable and easy to use

When selecting a new boiler, you are making a decision that can have an effect on your daily life for many years. You determine how relaxed you feel and how much you have to worry about maintenance and cleaning. This is where quality at a fair price pays!

### Automatically clean

The ETA ePE BW cleans itself automatically – and not just at certain intervals, but precisely when it's needed. This ensures low emission values and the highest degree of efficiency during the heating season. You never have to open the combustion chamber and get yourself dirty. Not only is the combustion chamber de-ashed effectively, the heat exchanger is also regularly cleared of deposits. As the pellets are burnt very efficiently, less ash is produced. In addition, the ash is compacted in the ash box. Which is why it only needs to be emptied occasionally. And this is easily and quickly done.

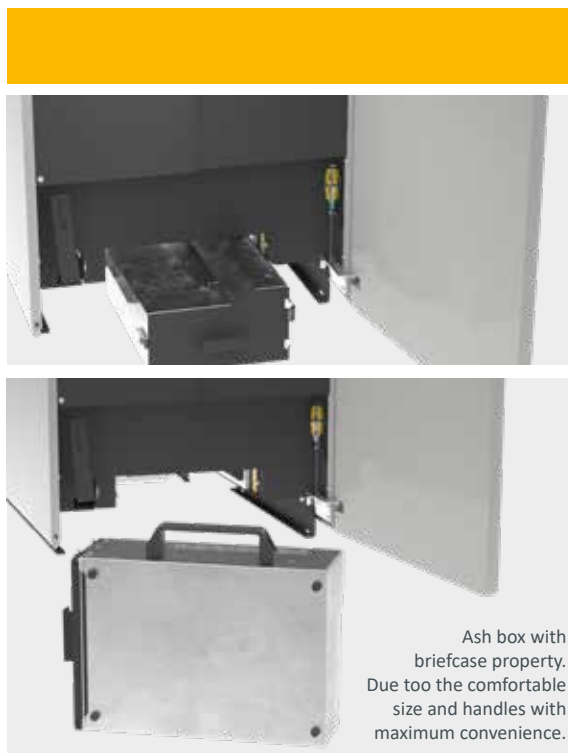

Ash box with briefcase property. Due too the comfortable size and handles with maximum convenience.

## Rotary valve

**The safe system.** The rotary valve completely protects you from burn-back: burning should only take place in the combustion chamber and nowhere else.

A transport screw brings the pellets to the rotary valve – and only as many as the rotary valve can handle. This is why the pellets do not become wedged, crushed or broken. Thanks to this ETA developed system, the sealed edges of the rotary valve do not wear out. The system remains safe throughout the entire life of the boiler.

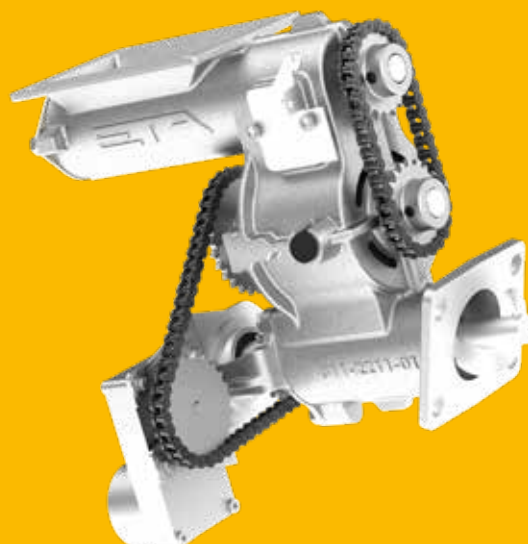





Rear view of the boiler  
You can find more information in  
the technical data on page 18

## Flexible connection options

### Quickly set up anywhere.

Thanks to the flexible connections for hydraulics, flue pipe, supply air and condensate, you can install the ETA ePE BW not only on the wall, but also in a corner. During installation, the hydraulic connections can easily be turned to the left or right in the desired direction, the condensate drain can be located on the right, left or rear, and the supply air and flue gas connections are optionally on the left or rear.

### Operation with external air supply.

The ETA ePE BW can take the oxygen required for combustion from outside instead of from the ambient air inside. This means the boiler can also be located within a heated building shell, without having to permanently open a window in the deepest of winter.

## Noiseless ceramic igniter

**Sparking technology.** The energy used for ignition is much lower than other ignition systems. The ignition itself works quicker.



## Lambda probe

**It's about the mix.** With its help, the ratio of fuel and oxygen are mixed perfectly. This means that different pellet qualities achieve the best possible efficiency. In addition, the probe immediately detects if the ignition was successful. This reduces the ignition time and saves power and money.

## Control system

### Versatile, but not complicated.

Whether combustion control, pellet conveying, buffer management, domestic hot water preparation, weather-compensated heating circuit controlled with a weekly program for two circuits or the connected solar heating system: all of this can be controlled via a touchscreen directly on the boiler or via the internet from any PC, smartphone or tablet. It is a lot, but it is easy to handle as the images on the touchscreen are self-explanatory.



## The way to heat

From pellet hopper to combustion chamber to pump: the interplay of high-quality components is needed!

- 1 Aspirator:** It transports the pellets from the store room to the boiler's intermediate hopper.
- 2 Pellet intermediate hopper:** Here 30 kg to 75 kg of pellets are stored temporarily and are immediately available for use. This means pellets have to be transported from the store room to the boiler only once or twice a day for approx. 5 minutes. You can even control when that is.
- 3 Rotary valve as burn-back protection:** It is the completely sealed closing door between store and combustion chamber and therefore safely protects against burn-back.
- 4 Automatic de-ashing in the ash box:** The small amount of ash that still falls despite the optimised combustion processes is firmly compacted in the ash bin. The ash bin only needs to be emptied every now and again. When it's time, the boiler sends a reminder by email.
- 5 Draught fan:** Quiet as a whisper, this fan ensures underpressure in the boiler. Additionally, it controls the air quantity and thus ensures safety in the boiler room.



The way through the boiler:

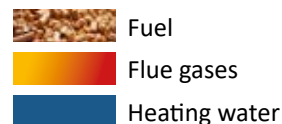

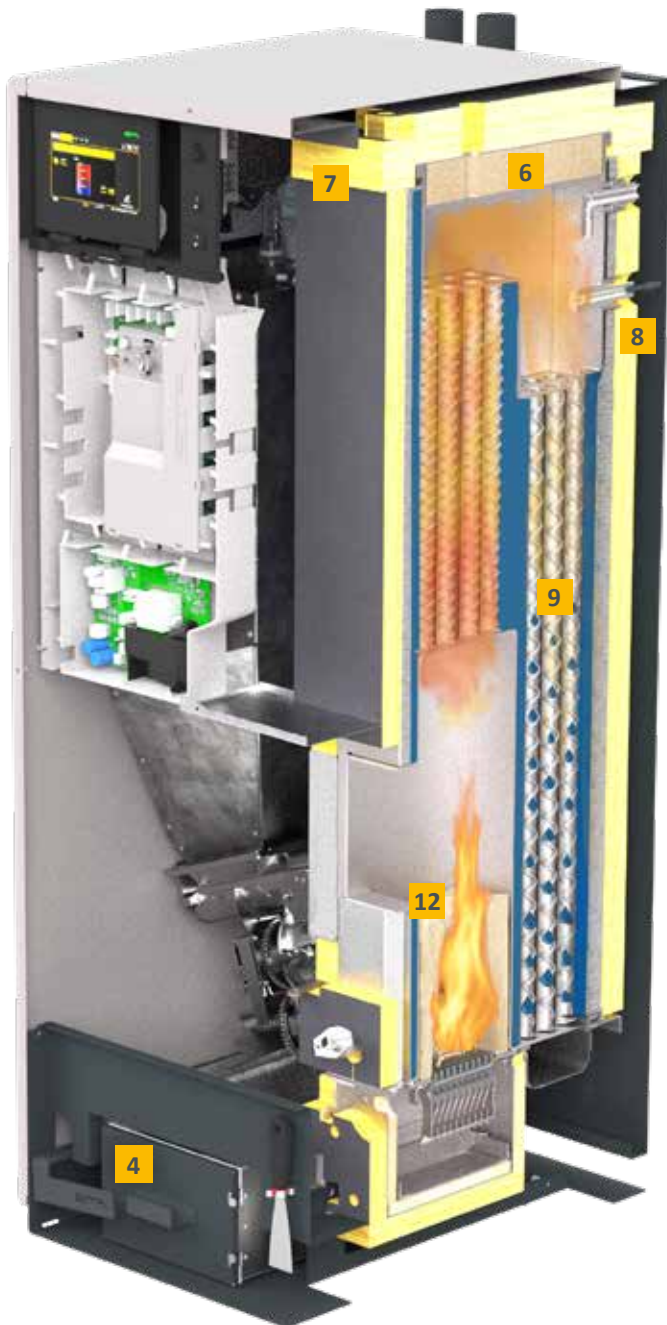

- 6 Lambda probe:** With its help, the ratio of fuel and oxygen are mixed perfectly. This means that different pellet qualities always achieve the best possible efficiency.
- 7 Safety devices:** A safety valve and an electronic pressure sensor protect the boiler from overpressure. An automatic bleed valve is also integrated, so unwanted air is removed from the water circuit. The boiler does not need a thermal emergency cooling valve, as there is never too much fuel in the boiler that could cause overheating.
- 8 Precipitator:** The optional integrated precipitator reduces the dust load in the flue gas to a minimum. The environment loves it!
- 9 Stainless steel condensing heat exchanger:** To prevent valuable energy from being wasted through the chimney, it extracts the residual heat from the flue gas and adds it back to the boiler water.
- 10 Mixer:** It can be flexibly used depending on system type. With a pluggable actuator, it functions as a flow mixing valve for a heating circuit or as a return riser with mixer for buffer storage tank operation.
- 11 Pump:** It is speed-controlled, highly efficient, energy-saving and ensures the optimum movement of hot water. Depending on the system type, it is either the heating circuit pump for an underfloor heater or radiator heating or it handles buffer charging.
- 12 Combustion chamber:** Here, temperatures are produced that are high enough to burn wood cleanly and efficiently. This ensures less ash and low emissions, even under partial load.
- 13 Heating circuit for ePE-BW 8-22:** The optional integrated heating circuit is installed in the boiler to save space. This means that no mixer or pump has to be installed externally in the boiler room for this heating circuit.
- 14 Condensate drain:** The condensate produced in the condensing heat exchanger is discharged into the waste water system via a siphon.



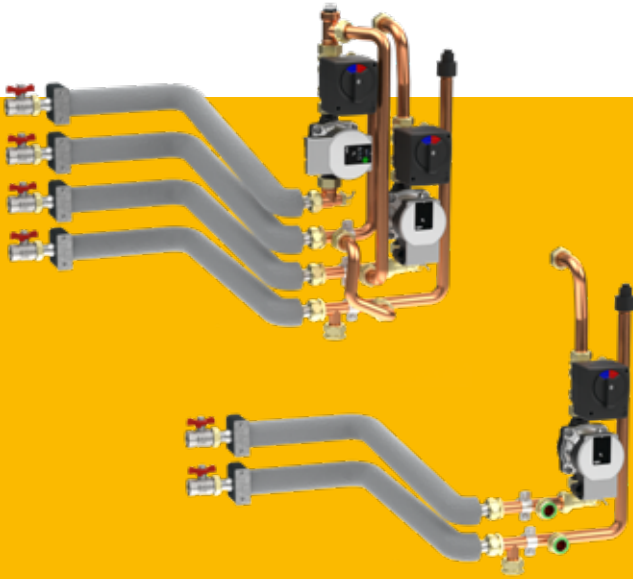

## Everything already in it

The most important elements for the heat distribution such as the pump, mixer and changeover valve are also integrated into the boiler like the safety valve, manometer and bleed valve.

Only ePE-BW 8-22: Optionally, the installation of a mixing circuit for buffer operation or an additional heating circuit for operation without buffer tank is possible. That saves space and make the installation easier.

## Draught fan

**Negative pressure in the boiler.** Quiet as a whisper, this speed-controlled fan ensures negative pressure in the boiler and determines the air quantity for the combustion. Energy-saving it ensures consistent combustion results – largely independent of the condition of the chimney.

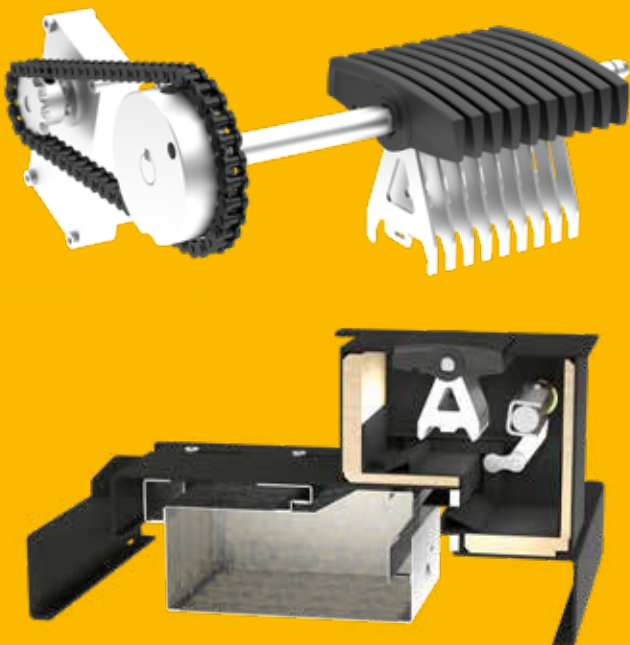

## Revolving grate with cleaning comb

**Clean burns well.** This patented system cleans the combustion chamber of ash regularly – automatically after pellets are burnt. The air required for the combustion process is distributed evenly between the clean grate segments. Additionally, the grate is constantly kept in slight motion. The gentle movement stokes the firebed and thus ensures even better combustion.

The ash is compacted and ends up in the 12 l capacity ash box. Even at full load operation, it only has to be emptied from time to time. When it is needed, the system sends an email or an SMS message. The information is also displayed on the touch display.



## ETA BW condensing heat exchanger

The ETA ePE BW even makes optimum use of the flue gas. Depending on the heating water temperature required, the integrated stainless steel condensing heat exchanger saves up to 10% fuel by extracting energy from the flue gases before they are discharged through the chimney. The flue gas is cooled below the dew point and the released heat is fed into the heating water. The best effect is achieved in combination with a panel heating system or when using a fresh water module for hot water preparation, i.e. whenever the return temperatures are low.

### Automatic dedusting

The system cleans itself, partly simply with the condensation water. If necessary, it is additionally flushed. A volume flow sensor determines the amount of water and thus ensures the lowest possible water consumption based on demand.



## Precipitator

### Clever use of a natural phenomenon

Why does dust keep building up on the computer screen? It is because the dust particles are electrostatically charged and are attracted by the screen. – ETA makes use of this effect in its precipitator. With the aid of an electrode in the flue gas duct the particles which are swirling in the flue gas are energised and ionised. They are deposited on the internal wall of the separator and can no longer escape from the chimney with the flue gases.



The optional precipitator makes heating with wood even cleaner and more environmentally friendly. It extracts the dust from the flue gases by means of electric current.

## Simple and can be controlled from anywhere

Good technology is characterized by being user-friendly. You don't have to be a technician to use ETAtouch's many functions.

### ETAtouch: the touchscreen as heating control

The days of confusingly arranged buttons and controls are over, because with the touchscreen of the ETA control system you can make all settings conveniently and easily. The icons are self-explanatory. Whether you generally have warmer or cooler temperatures, want to change the time for night setback or want to switch to setback mode during your vacation - you will intuitively tap on the right illustration without any operating instructions!

You can control your heating system via touchscreen and also have an overview of all integrated components such as buffer tanks, solar systems or hot water tanks.



*Heating, night setback, Holiday setting: the operation is immediately clear*



### the free of charge internet platform

If your ETA control is connected to the internet, you can view and change all heating settings on your smart phone, tablet or PC. So you have your heating under control, no matter where you are!

When you log in at [www.meinETA.at](http://www.meinETA.at), you will see the touchscreen exactly as if you were standing directly in front of the boiler. If necessary, mein-ETA will also inform you free of charge by email about your heating system.

Within your own house network, direct access to the ETAtouch control of your heating system can also be achieved via VNC.

### Quick help

Give your installer temporary access rights to your meinETA account. This way he can prepare for his visit to you. And maybe the technician doesn't even have to come because, thanks to myETA, he can tell you over the phone what you need to do to ensure that your heating system is optimally adjusted. You can see who can access your control via the status display. You always decide who belongs to your partner network!



### For tablets, smartphones and PCs

meinETA runs on all common operating systems such as iOS or Android. meinETA can be loaded via PC using any modern internet browser.





Everything is very simple



**Perfect for your smart home**

The ETAtouch control can be easily integrated into common smart home systems as well as into a building management system (BMS). The mini server of the Loxone system exchanges data directly with the boiler via a ModbusTCP interface. And all you need to connect to a KNX bus system is the optionally available ETA KNX interface and a few simple clicks.

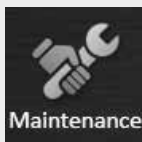

# Maintenance assistant

Simply maintain your boiler yourself: the instructions on the boiler's touch display guide you step by step through the annual cleaning.

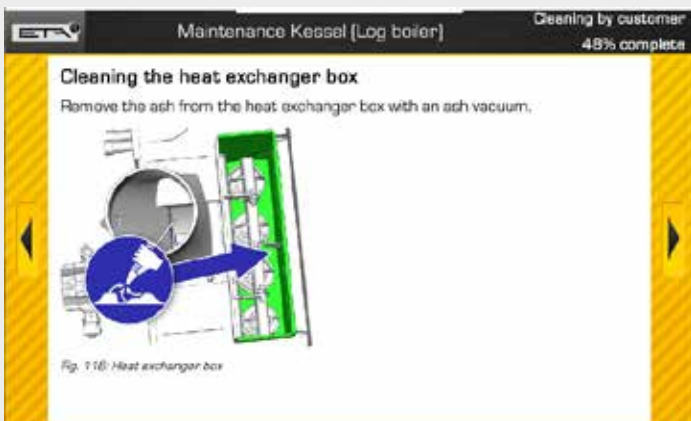

**ETA individual room control interface example:**

Whether Loxone, KNX or ETA individual room sensor with or without display: everything can be controlled via ETAtouch. It always passes on the correct signals to the valve controllers, which control how much hot water should come through to the respective room or heating section.

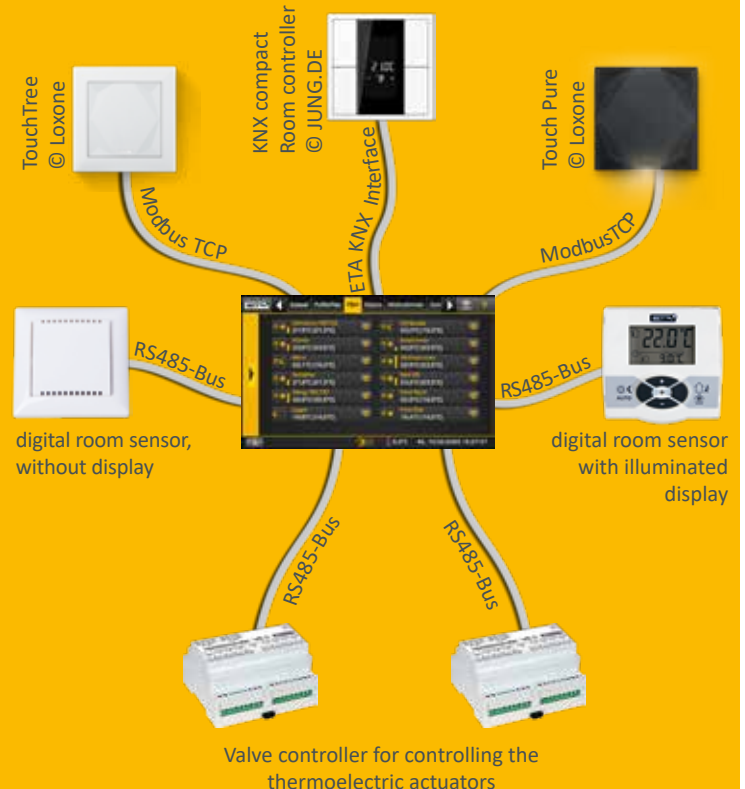

# Everything on one display: the ETA Standard

A modern heating system is only effective if it is well-controlled. ETAtouch takes care of that.

At no added cost, the ETAtouch control system already includes all functions for two heating circuits, hot water supply via tank or instantaneous hot water module, as well as for the integration of a solar heating system. All ETA heating boilers also come with a LAN connection as standard. If you connect the boiler to the internet, you can easily control all components from a PC, tablet or smartphone.

## Boiler and combustion regulation\*

Speed-controlling the several components save power. The lambda and ignition time regulation increases efficiency. All components relevant to operation are monitored.

## Buffer storage tank management\*\*

Three to nine sensors in the tank control the heat generator in the system and distribute the energy to the different consumers. From using five sensors, cascading regulation, QM-Holz and peak load management are part of the ETA Standard.

## Domestic hot water preparation\*

Is made possible both via the ETA instantaneous hot water module but also via the hot water tank or combination tank. For all variants, circulation pumps can be controlled with time and/or requirement programs.

## Solar heating systems\*\*

Single or double circuit solar heating systems with one or two tanks, zone loading via the ETA stratified charging module and also two collector fields as well as three consumers are controlled.

## Two weather-controlled mixing heating circuits\*\*

They run with a weekly program which allows many time windows and automatic and/or manual additional functions. The system can optionally be expanded with room sensors and remote control.



*Comprehensible also without the need for an operating manual: The symbols on the touchscreen are self-explanatory. So controlling the heating system becomes child's play.*

## Additional system functions

Detection of third-party heating devices, such as oil boilers, gas boilers, heat pumps and wood burning stoves, thermostat or differential temperature thermostat, external demand from external devices such as heating fans, control of transmission lines, with or without mixers, and also of heat transfer stations, single room control systems, for example.

## Wall-mounted control box for more complex systems

All control systems can be extended with wall-mounted control boxes, with or without touchscreen.

\* Control system and sensor included in standard delivery scope  
 \*\* Control system depends on configuration, sensors are available as accessory

# From Hausruckviertel to the world

ETA specialises in the manufacture of biomass heating, i.e. log, pellet and wood chip boilers. The most modern technologies combined with naturally growing resources.

## ETA is efficient

Technicians designate the efficiency of a heating system with the Greek letter  $\eta$ , pronounced „eta“. ETA boilers stand for more heat with less fuel consumption, environmental soundness and sustainability.

## Wood: old but excellent

Wood is our oldest fuel - and our most modern: There is a lot of history - from open fires in front of caves to modern biomass boilers. In the middle of the 20th century, the number of wood heating systems briefly fell. Oil heating became the new, hyped option. A brief interlude in comparison to the consistency of wood. Today, we know that heating with fossil fuel has no future. It contributes to global warming and harms the environment. Supply security is also not guaranteed in the long term, as fossil fuels are being depleted, aren't renewable and often come from unstable regions. While wood by contrast is a cheaper, locally grown, renewable raw material that does not pollute the climate when burnt. No wonder wood heating is booming!

## Comfort with many components

Since December 1998, the Upper Austrian company ETA has been designing and building a new generation of wood-fired boilers. They are full of patented technologies and the most modern control technology – making them easy to use. Convenience and efficiency make ETA products so popular around the world. With a production capacity of up to 35,000 boilers per year and a global export proportion of around 80%, ETA is one of the leading biomass boiler producers.

## You get more than just a boiler

Anyone who decides on a wood or pellet boiler from ETA is choosing sustainability. This is not just in terms of fuel, but encompasses responsibility across the board, with sustainable workplaces in the region. More than 400 employees in Hofkirchen an der Trattnach have the best working conditions – including an in-house restaurant, bright assembly and storage halls, a fitness room and a sauna. There is even a free electric charging station for electric cars, which is supplied by the in-house photovoltaic system. This also covers all the power needed of a production hall and thus saves around 230 tonnes of CO<sub>2</sub> per year.





# Pellets boiler ETA ePE BW 8 to 14 kW

- |  |   |
|--|---|
| <b>1</b> Pellet suction hose, pellet return air DN50                 | <b>6</b> Flue gas connection                                  |
| <b>2</b> Outlet for safety valve                                     | <b>7</b> Outlet for condensate, DN 50                         |
| <b>3</b> Flow, 3/4" ball valve                                       | <b>8</b> Water connection for the flushing water              |
| <b>4</b> Return, 3/4" ball valve                                     | <b>9</b> Optional: flow heating circuit 2, 3/4" ball valve    |
| <b>5</b> Air connection for operation with external air supply, DN80 | <b>10</b> Optional: return heating circuit 2, 3/4" ball valve |

Optimum maintenance area. Fixed components (e.g. expansion tank, hot water tank) in this area may require more cleaning and maintenance. The dimensions marked with an asterisk symbol (\*) indicate the minimum dimensions for the maintenance area.

X = Dimension variable depending on the connection pipe to the chimney

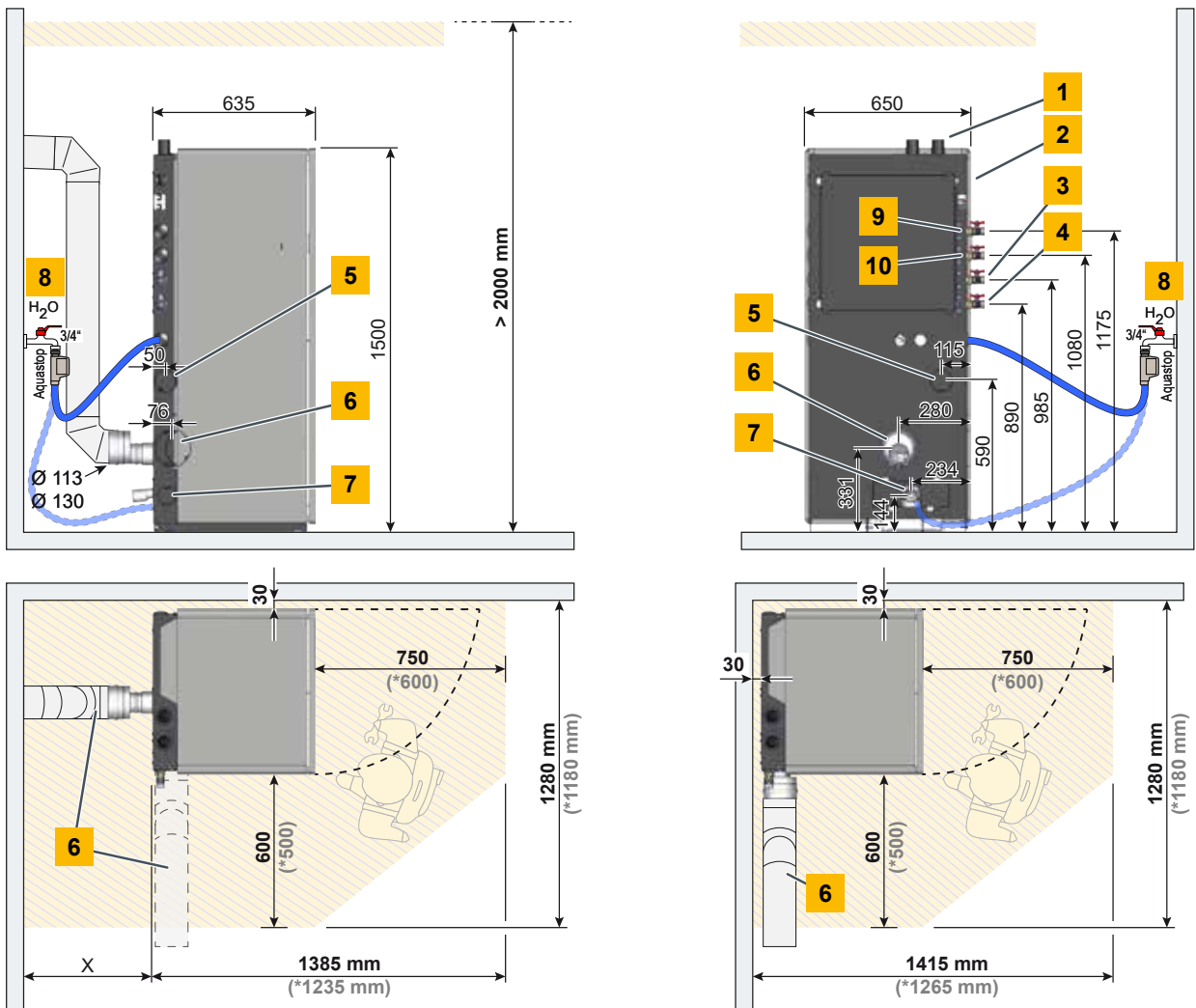



Pellet condensing boiler ePE-BW	Unit	8	10	12	14
Rated heat capacity range (for condensing operation)	kW	2.4 - 8	3 - 10	3.6 - 12	4.2 - 14
Rated heat capacity range (non-condensing operation)	kW	2.3 - 7.6	2.9 - 9.5	3.4 - 11.4	4 - 13.3
Efficiency (for condensing operation) at partial / full load	%	104.8 / 104.7	104.7 / 104.5	104.6 / 104.3	104.6 / 104.3
Efficiency (non-condensing operation) at partial / full load	%	97.5 / 98	97.8 / 98.2	98 / 98.3	97.9 / 98.3
Energy efficiency class "package-system"		A++	A++	A++	A++
Transport dimensions, W x D x H	mm	650 x 635 x 1550			
Weight	kg	245			
Water content	litres	41			
Free residual pump head (at $\Delta T = 20$ K) for operation with a buffer or radiators	mWS	7.5	7.1	6.7	6
	m <sup>3</sup> /h	0.34	0.43	0.52	0.60
Free residual pump head (at $\Delta T = 7$ K) for operation of under-floor heating For direct operation of an underfloor heating circuit, the maximum output is 14 kW.	mWS	5.7	4.6	3.4	2.3
	m <sup>3</sup> /h	0.98	1.23	1.48	1.72
Maximum distance to pellet store	m	20			
Ash box volume	litres	13.5			
Required flue draught Up to 3 Pa overpressure in the flue pipe is permissible. No draught limiter or deflagration damper may be installed.	Pa	0			
Electrical power consumption at partial / full load (=values with integrated precipitator)	W	28 / 43 (48 / 64)			
Electrical power consumption in standby	W	7			
Maximum permissible operating pressure	bar	3			
Temperature adjustment range	°C	30 - 90			
Boiler class		5 according to EN 303-5			
Suitable fuels		Pellets EN ISO 17225-2-A1, ENplus-A1			
Electrical connection		1 x 230 V / 50 Hz / 13 A			
Mode of operation		Condensing			

Subject to technical changes and errors

# Pellets boiler ETA ePE BW 16 to 22 kW

- |  |   |
|--|---|
| <b>1</b> Pellet suction hose, pellet return air DN50                 | <b>6</b> Flue gas connection                                  |
| <b>2</b> Outlet for safety valve                                     | <b>7</b> Outlet for condensate, DN 50                         |
| <b>3</b> Flow, 3/4" ball valve                                       | <b>8</b> Water connection for the flushing water              |
| <b>4</b> Return, 3/4" ball valve                                     | <b>9</b> Optional: flow heating circuit 2, 3/4" ball valve    |
| <b>5</b> Air connection for operation with external air supply, DN80 | <b>10</b> Optional: return heating circuit 2, 3/4" ball valve |

Optimum maintenance area. Fixed components (e.g. expansion tank, hot water tank) in this area may require more cleaning and maintenance. The dimensions marked with an asterisk symbol (\*) indicate the minimum dimensions for the maintenance area.

X =Dimension variable depending on the connection pipe to the chimney

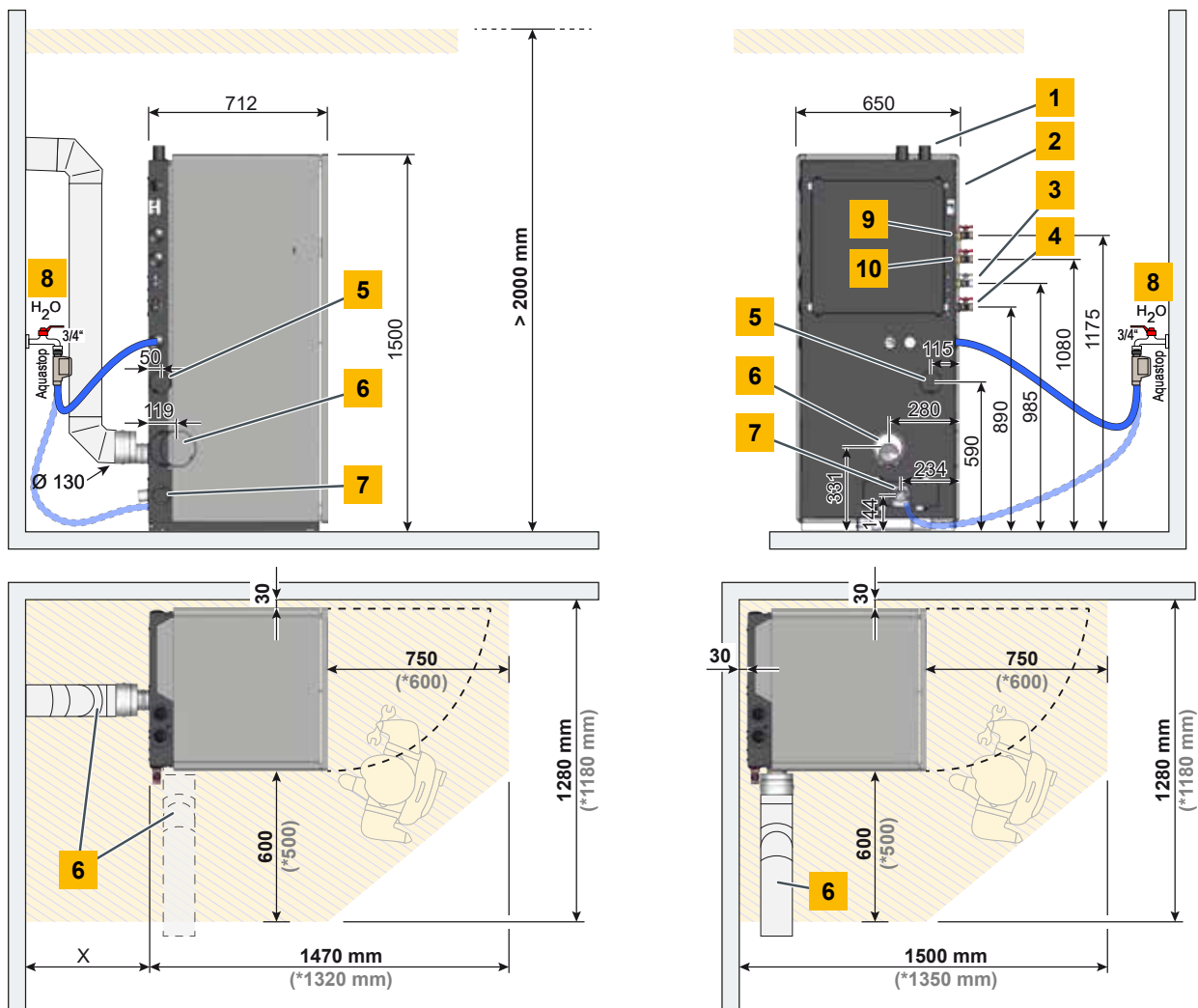





Pellet condensing boiler ePE-BW	Unit	16	18	20	22
Rated heat capacity range (for condensing operation)	kW	4.8 - 16	5.4 - 18	6 - 20	6.6 - 22
Rated heat capacity range (non-condensing operation)	kW	4.6 - 15.2	5.1 - 17.1	5.7 - 19	6.3 - 20.9
Efficiency (for condensing operation) at partial / full load	%	104.6 / 104.3	104.6 / 104.3	104.6 / 104.3	104.6 / 104.3
Efficiency (non-condensing operation) at partial / full load	%	97.7 / 98.3	97.6 / 98.3	97.4 / 98.3	97.3 / 98.3
Energy efficiency class "package-system"		A++	A++	A++	A++
Transport dimensions, W x D x H	mm	650 x 712 x 1528			
Weight	kg	273			
Water content	litres	49			
Free residual pump head (at $\Delta T = 20$ K) for operation with a buffer or radiators	mWS	6.6	6.1	5.5	5
	m <sup>3</sup> /h	0.69	0.78	0.86	0.94
Free residual pump head (at $\Delta T = 7$ K) for operation of under-floor heating For direct operation of an underfloor heating circuit, the maximum output is 14 kW.	mWS	2.3	2.3	2.3	2.3
	m <sup>3</sup> /h	1.72	1.72	1.72	1.72
Maximum distance to pellet store	m	20			
Ash box volume	litres	15			
Required flue draught Up to 3 Pa overpressure in the flue pipe is permissible. No draught limiter or deflagration damper may be installed.	Pa	0			
Electrical power consumption at partial / full load (=values with integrated precipitator)	W	28 / 56 (43 / 64)			
Electrical power consumption in standby	W	7			
Maximum permissible operating pressure	bar	3			
Temperature adjustment range	°C	30 - 90			
Boiler class		5 according to EN 303-5			
Suitable fuels		Pellets EN ISO 17225-2-A1, ENplus-A1			
Electrical connection		1 x 230 V / 50 Hz / 13 A			
Mode of operation		Condensing			

Subject to technical changes and errors

Complies with  
EU standards



Austrian Ecolabel



# Pellets boiler

## ETA ePE BW 28 to 44 kW

- |  |  |
|--|--|
| <ul style="list-style-type: none"> <li><b>1</b> Pellet suction hose, pellet return air DN50</li> <li><b>2</b> Outlet for safety valve</li> <li><b>3</b> Flow, 5/4" ball valve</li> <li><b>4</b> Return, 5/4" ball valve</li> </ul> | <ul style="list-style-type: none"> <li><b>5</b> Air connection for room air independent operation, DN100</li> <li><b>6</b> Flue gas connection</li> <li><b>7</b> Outlet for condensate, DN 50</li> <li><b>8</b> Water connection for the flushing water</li> </ul> |
|--|--|

Optimum maintenance area. Fixed components (e.g. expansion tank, hot water tank) in this area may require more cleaning and maintenance. The dimensions marked with an asterisk symbol (\*) indicate the minimum dimensions for the maintenance area.

X = Dimension variable depending on the connection pipe to the chimney

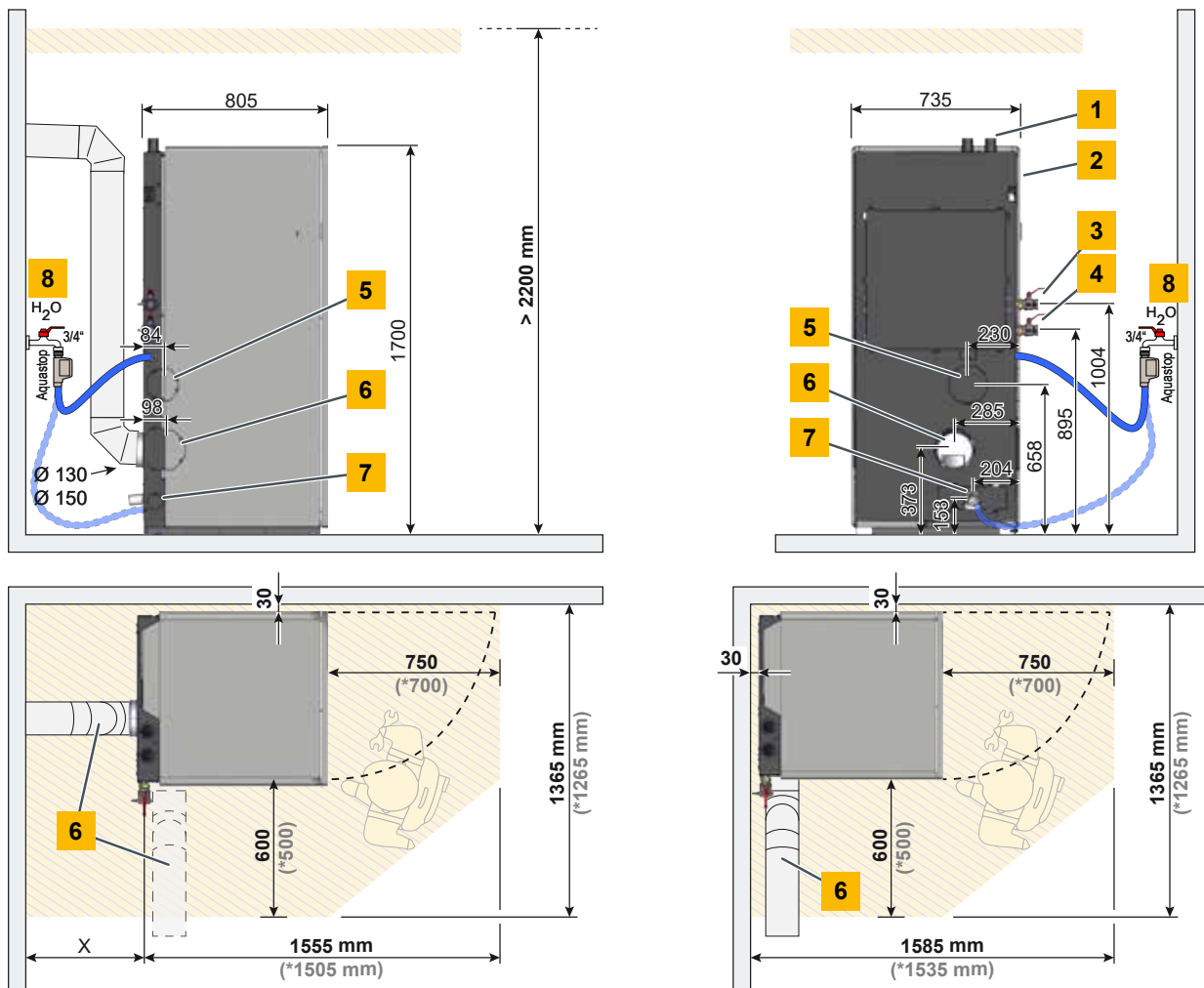



Pellet condensing boiler ePE-BW	Unit	28	36	44
Rated heat capacity range (for condensing operation)	kW	8.4 - 28	10.8 - 36	13.2 - 44
Rated heat capacity range (non-condensing operation)	kW	7.9 - 26.6	10.2 - 34.2	12.5 - 41.8
Efficiency (for condensing operation) at partial / full load	%	104.3 / 104	103.8 / 103.6	104 / 103.5
Efficiency (non-condensing operation) at partial / full load	%	97 / 97.8	96.6 / 97.1	97.1 / 97.3
Energy efficiency class "package-system"		A++	A++	A++
Transport dimensions, W x D x H	mm	740 x 805 x 1733		
Weight	kg	391		
Water content	litres	84		
Free residual pump head (at $\Delta T = 20$ K) for operation with a buffer	mWS	4.2	2.8	2.2
	m <sup>3</sup> /h	1.21	1.55	1.89
Maximum distance to pellet store	m	20		
Ash box volume	litres	21		
Required flue draught Up to 3 Pa overpressure in the flue pipe is permissible. No draught limiter or deflagration damper may be installed.	Pa	0		
Electrical power consumption at partial / full load (=values with integrated precipitator)	W	42 / 67 (55 / 84)	61 / 81 (81 / 110)	50 / 79 (70 / 106)
Electrical power consumption in standby	W	7		
Maximum permissible operating pressure	bar	3		
Temperature adjustment range	°C	30 - 90		
Boiler class	5 according to EN 303-5			
Suitable fuels	Pellets EN ISO 17225-2-A1, ENplus-A1			
Electrical connection	1 x 230 V / 50 Hz / 13 A			
Mode of operation	Condensing			

*Subject to technical changes and errors*

Complies with  
EU standards



Austrian Ecolabel





# Pellets boiler ETA ePE BW 50 to 62 kW

- |  |  |
|--|--|
| <ul style="list-style-type: none"> <li><b>1</b> Pellets suction hose, pellets return air DN50</li> <li><b>2</b> Connection for safety valve, pressure gauge and bleed valve, 3/4"</li> <li><b>3</b> Flow, 5/4" ball valve</li> <li><b>4</b> Return, 5/4" ball valve</li> </ul> | <ul style="list-style-type: none"> <li><b>5</b> Air connection for room air independent operation, DN150</li> <li><b>6</b> Flue gas connection</li> <li><b>7</b> Outlet for condensate, DN 50</li> <li><b>8</b> Water connection for the flushing water</li> </ul> |
|--|--|

Optimum maintenance area. Fixed components (e.g. expansion tank, hot water tank) in this area may require more cleaning and maintenance. The dimensions marked with an asterisk symbol (\*) indicate the minimum dimensions for the maintenance area.

X = Dimension variable depending on the connection pipe to the chimney

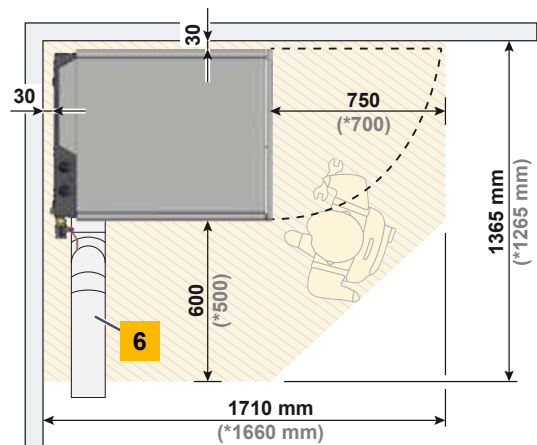
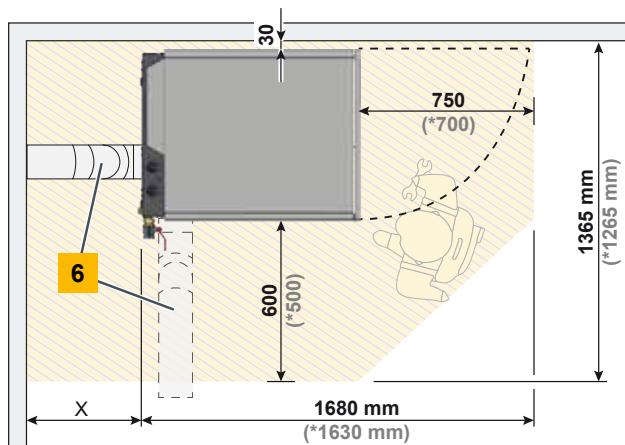
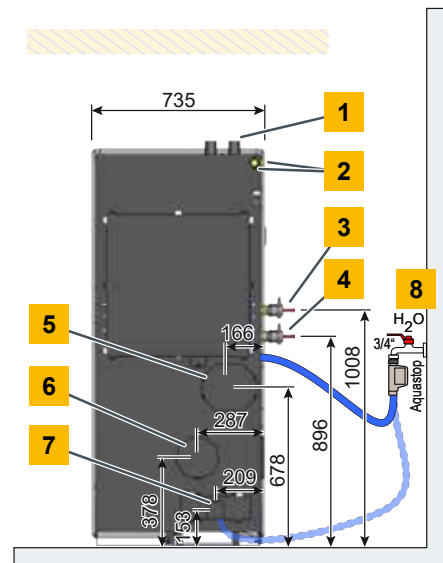
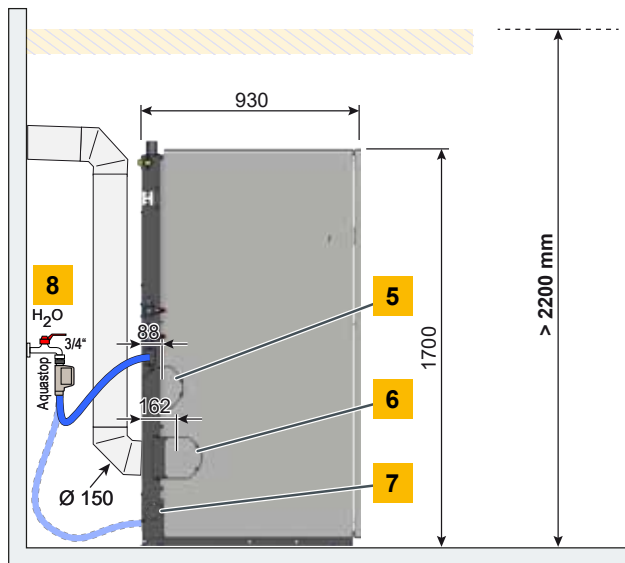



Pellet condensing boiler ePE-BW	Unit	50	55	62
Rated heat capacity range (for condensing operation)	kW	14.9 - 49.9	16.5 - 55	18.6 - 62
Rated heat capacity range (non-condensing operation)	kW	14.2 - 47.4	15.6 - 52.3	17.6 - 58.9
Efficiency (for condensing operation) at partial / full load	%	104.1 / 103.5	104.2 / 103.5	104.4 / 103.4
Efficiency (non-condensing operation) at partial / full load	%	97.5 / 97.4	97.8 / 97.5	98.2 / 97.7
Energy efficiency class "package-system"		A++	A++	A++
Transport dimensions, W x D x H	mm	735 x 930 x 1733		
Weight	kg	472		
Water content	litres	107		
Free residual pump head (at $\Delta T = 20$ K) for operation with a buffer	mWS	5.1	4.3	2.9
	m <sup>3</sup> /h	2.15	2.36	2.67
Maximum distance to pellet store	m	20		
Ash box volume	litres	23.8		
Required flue draught Up to 3 Pa overpressure in the flue pipe is permissible. No draught limiter or deflagration damper may be installed.	Pa	0		
Electrical power consumption at partial / full load (=values with integrated precipitator)	W	41 / 77 (62 / 104)	34 / 76 (55 / 101)	24 / 74 (45 / 98)
Electrical power consumption in standby	W	7		
Maximum permissible operating pressure	bar	3		
Temperature adjustment range	°C	30 - 90		
Boiler class	5 according to EN 303-5			
Suitable fuels	Pellets EN ISO 17225-2-A1, ENplus-A1			
Electrical connection	1 x 230 V / 50 Hz / 13 A			
Mode of operation	Condensing			

*Subject to technical changes and errors*

Complies with  
EU standards



Austrian Ecolabel



# NOTICES

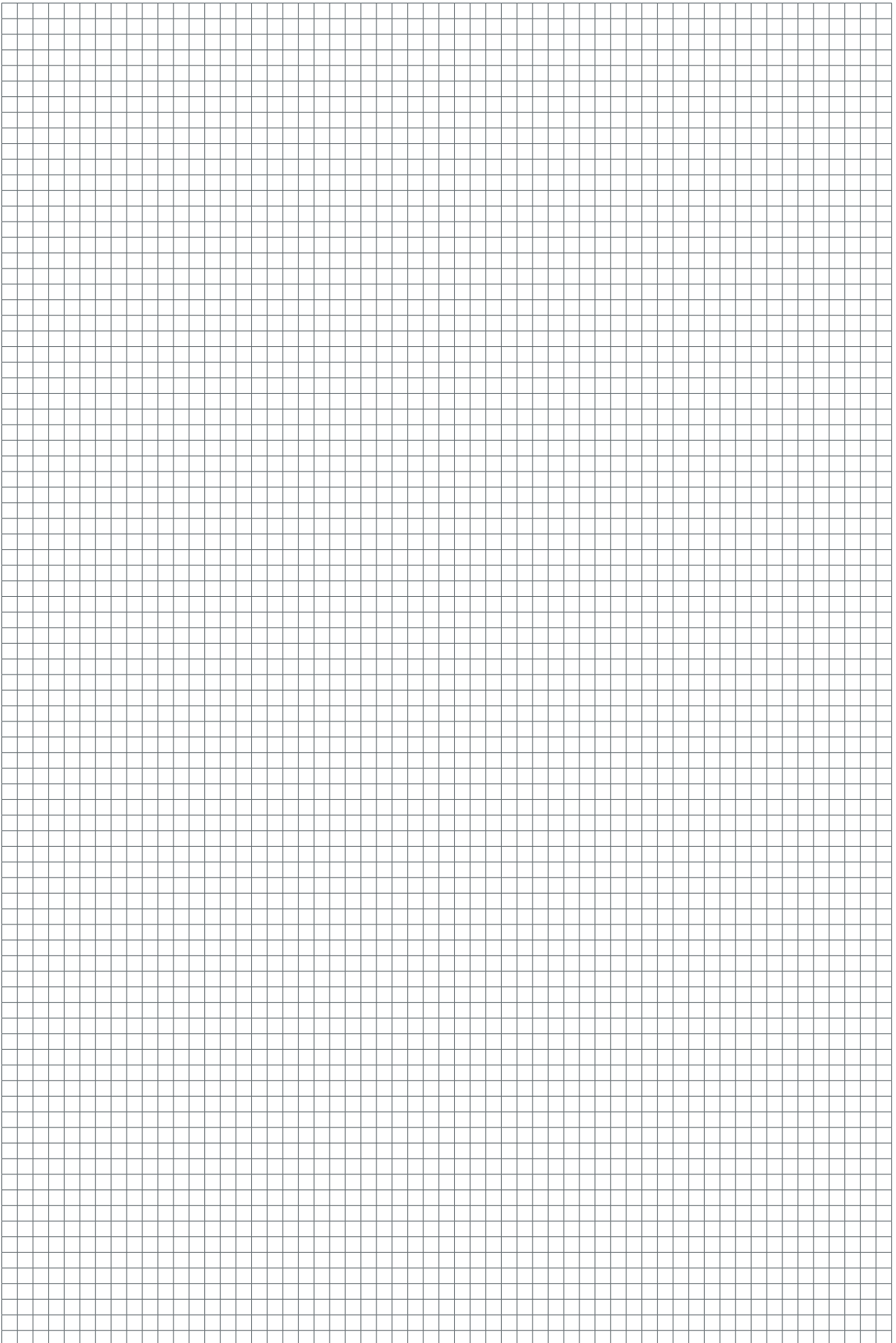



# NOTICES

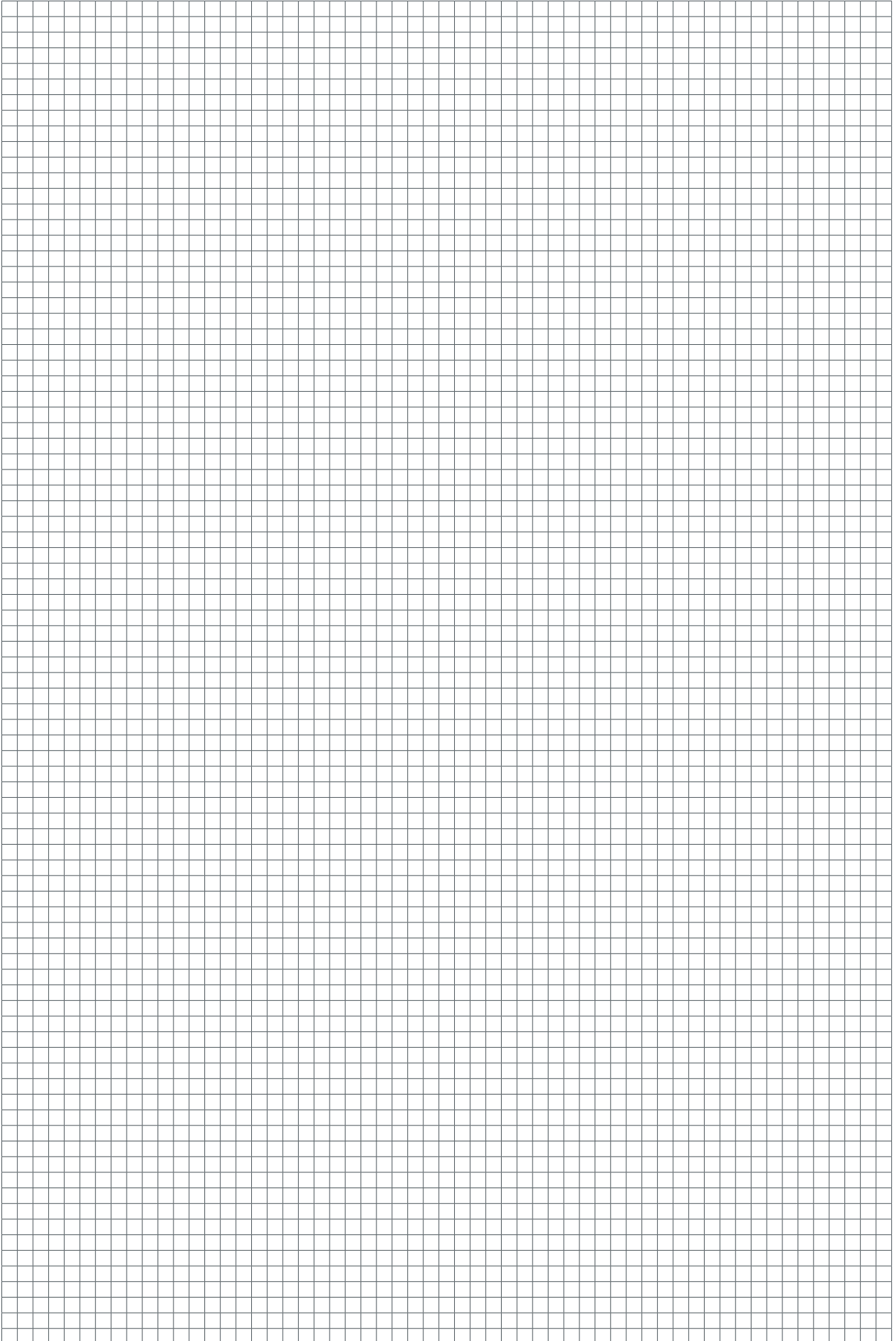



## ETA Pellets boiler

ETA PU PelletsUnit	7 - 15 kW
ETA ePE Pellets boiler	7 - 56 kW
ETA PC PelletsCompact	20 - 105 kW
ETA ePE-K Pellets boiler	100 - 240 kW



## ETA Condensing heat technology

ETA ePE BW Pellets boiler	8 - 62 kW
ETA BW Condensing heat exchanger PU	7 - 15 kW
ETA BW condensing heat exchanger PC	20 - 105 kW



## ETA SH Log wood boiler and TWIN Pellets boiler

ETA eSH Log wood boiler	16 - 40 kW
ETA eSH-TWIN Combination boiler with ETA eTWIN Pellets boiler	16 - 40 kW
ETA SH Log wood boiler	16 - 32 kW
ETA SH Log wood boiler	20 - 60 kW
ETA SH-P Log wood boiler with ETA TWIN Pellets boiler	20 - 60 kW
	20 - 50 kW



## ETA Wood chip boiler

ETA eHACK Wood chip boiler	20 - 240 kW
ETA HACK VR Wood chip boiler	250 - 500 kW

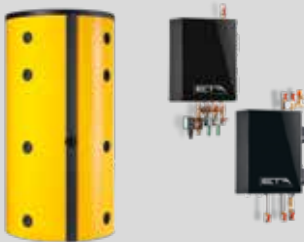

## ETA Buffer tank

ETA Buffer	500 l
ETA Buffer SP	600 - 5.000 l
ETA Buffer SPS	600 - 1.100 l

## ETA Hydraulic modules

ETA Fresh water module
ETA Stratified charging module
ETA System separation module
ETA Mixing circuit module
ETA Heat transfer module and station

Your heating specialist will be happy to advise you:



**ETA Heiztechnik GmbH**  
 Gewerbepark 1  
 A-4716 Hofkirchen an der Trattnach  
 Tel.: +43 7734 2288  
 Fax: +43 7734 2288-22  
 info@eta.co.at  
 www.eta.co.at

### Technical changes and mistakes reserved

In order to provide you the benefits of our continuous development, we reserve the right to change specifications without prior notice. Printing and typesetting errors or changes of any kind made in the interim are not cause for claims. Individual configurations depicted or described here are only available as options. In the event of discrepancies between individual documents regarding the scope of delivery, the information provided in our current price list shall prevail. Images and symbols may contain options that are available for an additional cost.

Photo source: ETA Heiztechnik GmbH, Lothar Prokop Photographie, istockphoto, Thinkstockphotos, Photocase, Shutterstock.  
 94740-EN, Prospekt ETA ePE BW EN, 2025-02

