

ETA eHACK  
20 to 240 kW



... my heating system



The wood chip boiler for  
agriculture and business



*A passion for perfection.*

[www.eta.co.at](http://www.eta.co.at)

# From Hausruckviertel to the world

ETA specialises in the manufacture of biomass heating, i.e. log, pellet and wood chip boilers. The most modern technologies combined with naturally growing resources.

## ETA is efficient

Technicians designate the efficiency of a heating system with the Greek letter  $\eta$ , pronounced „eta“. ETA boilers stand for more heat with less fuel consumption, environmental soundness and sustainability.

## Wood: old but excellent

Wood is our oldest fuel - and our most modern: There is a lot of history - from open fires in front of caves to modern biomass boilers. In the middle of the 20th century, the number of wood heating systems briefly fell. Oil heating became the new, hyped option. A brief interlude in comparison to the consistency of wood. Today, we know that heating with fossil fuel has no future. It contributes to global warming and harms the environment. Supply security is also not guaranteed in the long term, as fossil fuels are being depleted, aren't renewable and often come from unstable regions. While wood by contrast is a cheaper, locally grown, renewable raw material that does not pollute the climate when burnt. No wonder wood heating is booming!

## Comfort with many components

Since December 1998, the Upper Austrian company ETA has been designing and building a new generation of wood-fired boilers. They are full of patented technologies and the most modern control technology – making them easy to use. Convenience and efficiency make ETA products so popular around the world. With a production capacity of up to 35,000 boilers per year and a global export proportion of around 80%, ETA is one of the leading biomass boiler producers.

## You get more than just a boiler

Anyone who decides on a wood or pellet boiler from ETA is choosing sustainability. This is not just in terms of fuel, but encompasses responsibility across the board, with sustainable workplaces in the region. More than 400 employees in Hofkirchen an der Trattnach have the best working conditions – including an in-house restaurant, bright assembly and storage halls, a fitness room and a sauna. There is even a free electric charging station for electric cars, which is supplied by the in-house photovoltaic system. This also covers all the power needed of a production hall and thus saves around 230 tonnes of CO2 per year.



# A win-win situation

Save heating costs, strengthen your domestic economy and look after the environment in the process: heating with wood is worth it. Wood continuously regrows in our forests, thus it is crisis-proof and economical. Forested areas are growing across Europe.

While the price of fossil fuels such as oil and gas are subject to heavy fluctuations in the international markets and will certainly rise long-term, the price of wood and pellets is stable.

The natural raw material is CO<sub>2</sub>-neutral, this means that during its combustion no more CO<sub>2</sub> will be released than the tree took in during its growth. The same amount will also be released if the wood rots in the forest. So heating with wood doesn't burden our climate.

about 30 kg **CO<sub>2</sub>**  
is emitted when you

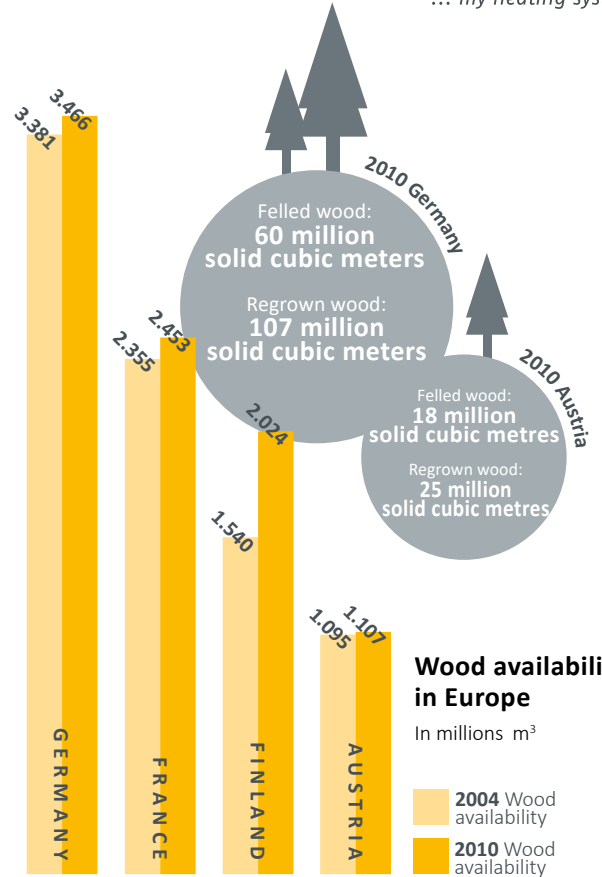
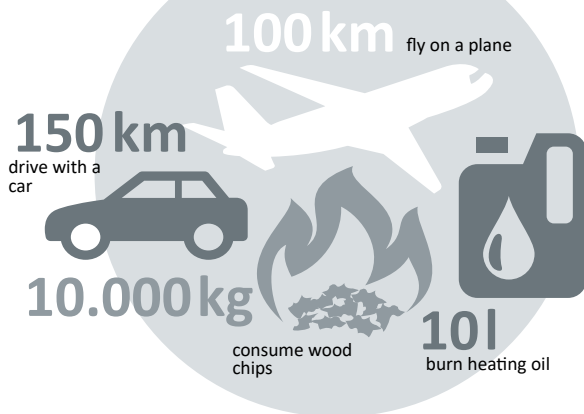

## Wood availability in Europe

In millions m<sup>3</sup>

2004 Wood availability  
2010 Wood availability

## Oil in comparison

Calculation time period: 5 years

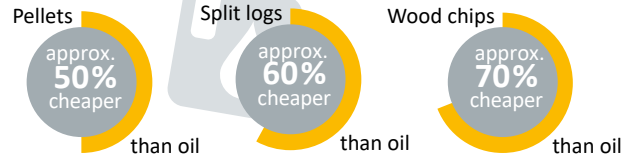

# Heat, just the way you need it

The ETA wood chip boiler doesn't just produce heat, the ETA System also distributes it efficiently. Rely on the perfect control centre for your heating and hot water system.

The ETA wood chip boiler is equipped with a control system for the entire heating system. Whether you want to integrate a solar heating system, a conventional hot water preparation system or a buffer storage tank with fresh water module, whether the energy is transferred with radiators or via underfloor or wall heating: You've got everything under control via a touchscreen on the boiler or also via computer or smartphone. Simple images show you if your solar heating system was successful or how full your buffer is.

## With buffer, please

The ETA buffer storage tank is a perfect partner. Especially when heating in autumn or in spring and for hot water preparation in the summer, often less

energy is needed than the heating boiler produces. The buffer stores this excess heat and releases it on demand. This saves fuel and protects the boiler, because fewer boiler starts are needed.

The ETA stratified buffer is ideal for the integration of a solar heating system. In summer hot water can be produced at virtually no operating costs, but in winter the solar collectors seldom produce the 60 °C that are common for hot water preparation. Then the water that is heated by solar energy is fed through the underfloor or wall heating. This usually works with hot water temperatures of just 30 to 40 °C.

*Remote controlled via the meinETA communication platform.*



*The ETA mixing circuit module for two heating circuits saves a lot of time and money during installation, as no sensor lines, pumps or mixer cables have to be installed.*



*Integrated return riser*

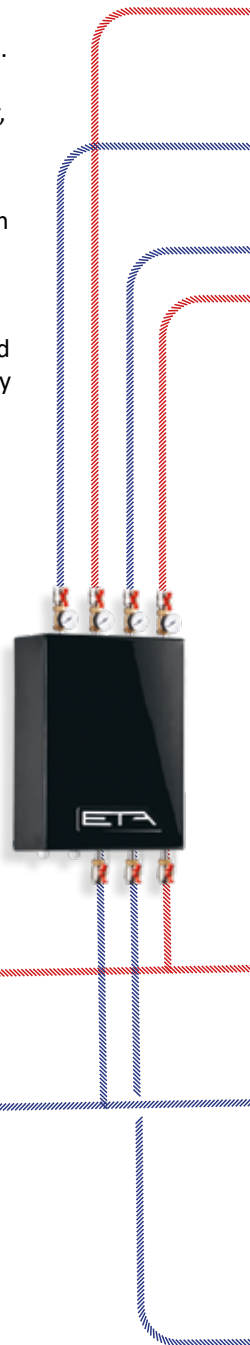

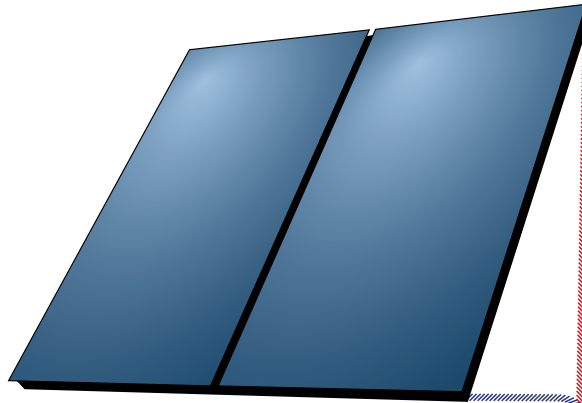

For smaller solar heating systems with large buffer storage tank volumes or for very large solar heating systems, the ETA stratified charging module ensures maximum efficiency.

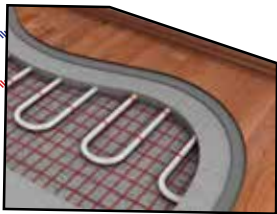

**Everything at a glance!**  
ETA room sensors display the most important parameters and make it easy to change the desired room temperature.

The ETA stratified buffer can also be equipped with a fresh water module, which constantly reheats the tap water with the help of a heat exchanger. This minimises the risk of germs and bacteria. The space requirement is much smaller thanks to the compact design. An optional circulation set ensures immediately available hot water for long pipelines.

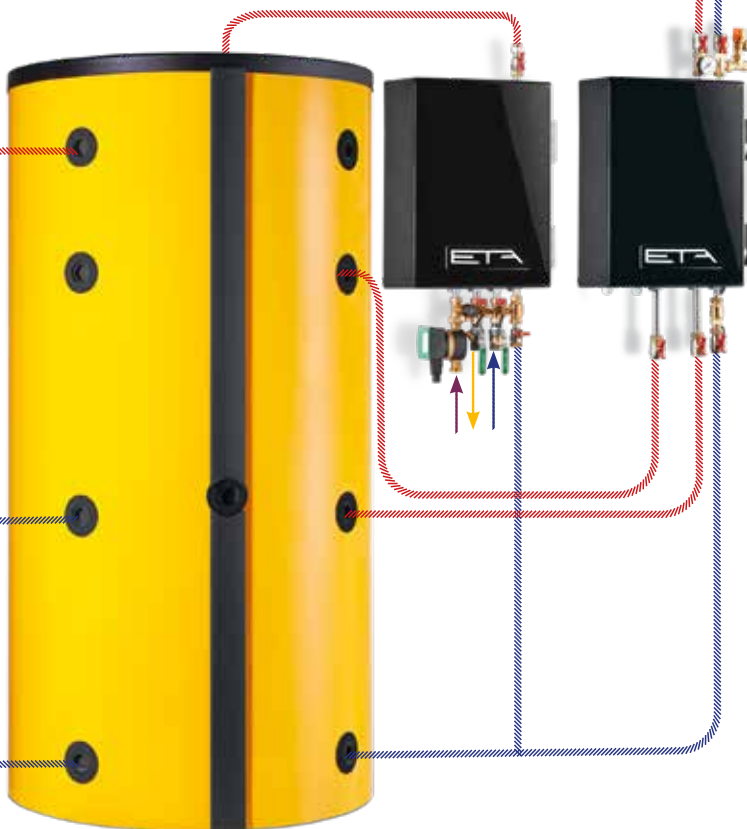

An ETA stratified buffer is the ideal addition to a wood chip boiler. It stores energy that is not required and delivers this on demand.



## Simple and can be controlled from anywhere

Good technology is characterized by being user-friendly. You don't have to be a technician to use ETAtouch's many functions.

### ETAtouch: the touchscreen as heating control

The days of confusingly arranged buttons and controls are over, because with the touchscreen of the ETA control system you can make all settings conveniently and easily. The icons are self-explanatory. Whether you generally have warmer or cooler temperatures, want to change the time for night setback or want to switch to setback mode during your vacation - you will intuitively tap on the right illustration without any operating instructions!

You can control your heating system via touchscreen and also have an overview of all integrated components such as buffer tanks, solar systems or hot water tanks.



*Heating, night setback, Holiday setting: the operation is immediately clear*



### the free of charge internet platform

If your ETA control is connected to the internet, you can view and change all heating settings on your smart phone, tablet or PC. So you have your heating under control, no matter where you are!

When you log in at [www.meinETA.at](http://www.meinETA.at), you will see the touchscreen exactly as if you were standing directly in front of the boiler. If necessary, mein-ETA will also inform you free of charge by email about your heating system.

Within your own house network, direct access to the ETAtouch control of your heating system can also be achieved via VNC.

### Quick help

Give your installer temporary access rights to your meinETA account. This way he can prepare for his visit to you. And maybe the technician doesn't even have to come because, thanks to myETA, he can tell you over the phone what you need to do to ensure that your heating system is optimally adjusted. You can see who can access your control via the status display. You always decide who belongs to your partner network!



### For tablets, smartphones and PCs

meinETA runs on all common operating systems such as iOS or Android. meinETA can be loaded via PC using any modern internet browser.



Everything is very simple



**Perfect for your smart home**

The ETAtouch control can be easily integrated into common smart home systems as well as into a building management system (BMS). The mini server of the Loxone system exchanges data directly with the boiler via a ModbusTCP interface. And all you need to connect to a KNX bus system is the optionally available ETA KNX interface and a few simple clicks.

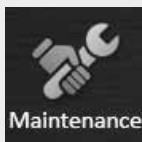

# Maintenance assistant

Simply maintain your boiler yourself: the instructions on the boiler's touch display guide you step by step through the annual cleaning.

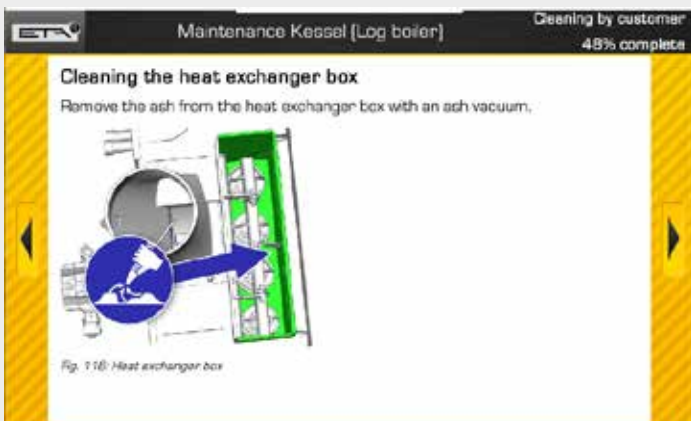

**ETA individual room control interface example:**

Whether Loxone, KNX or ETA individual room sensor with or without display: everything can be controlled via ETAtouch. It always passes on the correct signals to the valve controllers, which control how much hot water should come through to the respective room or heating section.

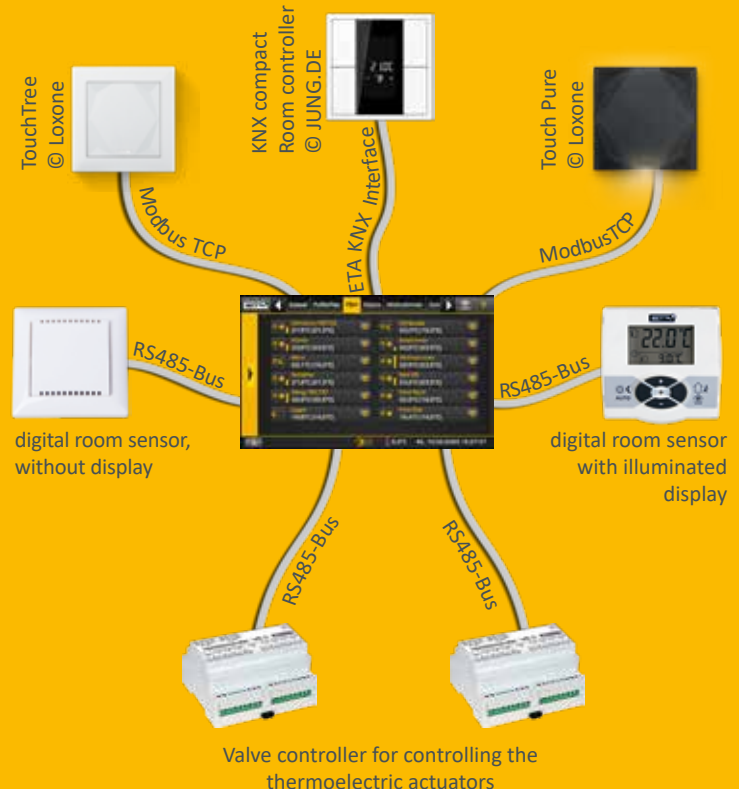

# Everything on one display: the ETA Standard

A modern heating system is only effective if it is well-controlled. ETAtouch takes care of that.

At no added cost, the ETAtouch control system already includes all functions for two heating circuits, hot water supply via tank or instantaneous hot water module, as well as for the integration of a solar heating system. All ETA heating boilers also come with a LAN connection as standard. If you connect the boiler to the internet, you can easily control all components from a PC, tablet or smartphone.

## Boiler and combustion regulation\*

Speed-controlling the several components save power. The lambda and ignition time regulation increases efficiency. All components relevant to operation are monitored.

## Buffer storage tank management\*\*

Three to nine sensors in the tank control the heat generator in the system and distribute the energy to the different consumers. From using five sensors, cascading regulation, QM-Holz and peak load management are part of the ETA Standard.

## Domestic hot water preparation\*

Is made possible both via the ETA instantaneous hot water module but also via the hot water tank or combination tank. For all variants, circulation pumps can be controlled with time and/or requirement programs.

## Solar heating systems\*\*

Single or double circuit solar heating systems with one or two tanks, zone loading via the ETA stratified charging module and also two collector fields as well as three consumers are controlled.

## Two weather-controlled mixing heating circuits\*\*

They run with a weekly program which allows many time windows and automatic and/or manual additional functions. The system can optionally be expanded with room sensors and remote control.



*Comprehensible also without the need for an operating manual: The symbols on the touchscreen are self-explanatory. So controlling the heating system becomes child's play.*

## Additional system functions

Detection of third-party heating devices, such as oil boilers, gas boilers, heat pumps and wood burning stoves, thermostat or differential temperature thermostat, external demand from external devices such as heating fans, control of transmission lines, with or without mixers, and also of heat transfer stations, single room control systems, for example.

## Wall-mounted control box for more complex systems

All control systems can be extended with wall-mounted control boxes, with or without touchscreen.

\* Control system and sensor included in standard delivery scope  
 \*\* Control system depends on configuration, sensors are available as accessory



# Efficiency and flexibility

Proper airflow is essential to ensure that the combustion process takes place safely and efficiently. Flue gas recirculation ensures this even for very dry wood chips, miscanthus or pellets.

- 1** Primary air through the segment rotating grate for output regulation
- 2** Secondary air on two levels for complete burnout
- 3** One-chamber rotary valve prevents uncontrolled air intake
- 4** Patented rotary screw seals the ash path between heat exchanger and combustion chamber
- 5** Draught fan ensures constant underpressure in the boiler and therefore also for the supply of the exact air quantity for the combustion
- 6** Controlled flue gas recirculation: the ducts are already integrated into the boiler, the drive unit required for activation is optionally available
- 7** A chimney draught regulator is required when using flue gas recirculation in order to guarantee optimum draught conditions

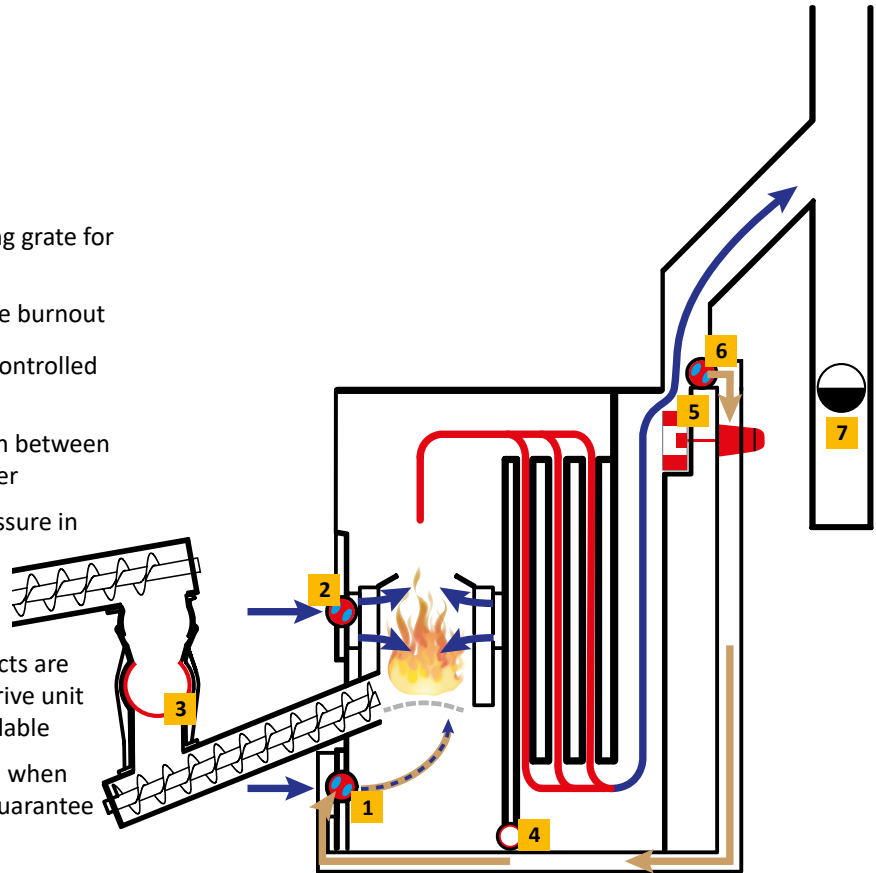

## Targeted air supply

The air required for combustion is sucked in according to information from the lambda probe and is directed by primary and secondary air valve in the combustion chamber to precisely where it is needed. Thus, the air supply can be adjusted perfectly according to fuel type. The airtight single-chamber rotary valve prevents any additional, unwanted air from entering the combustion chamber. This guarantees controlled and complete combustion.

## Integrated flue gas recirculation

ETA wood chip systems offer the advantage that the operator can use wood chips of differing qualities. Not just in terms of size. For very dry fuels like pellets, joinery waste fuel, miscanthus or wood chips with a water content below 15% a flue gas recirculation is used, a proven element of large-scale plants.

If necessary, a motor regulates the amount of flue gases that are returned to the combustion chamber. The combustion temperature in the degassing zones is therefore kept exactly at an ideal temperature, i.e. above 800 °C, but below 1,000 °C. So, on the one hand, all components of the fuel are completely separated, and on the other, the thermal stress on the components is minimised. This increases the lifetime of the boiler.

Combustion temperatures that are too high can also lead to undesirable slag formation.

# One-chamber rotary valve

**Uniquely safe:** ETA sets new safety standards with the sealed one-chamber rotary valve. In contrast to conventional burn-back flaps, there is never a position that results in a direct connection between the combustion chamber and the fuel store. Dangerous burn-back is prevented, as no hot gas from the combustion chamber can reach the fuel feeding system.

**Material-conserving fuel transport:** The one-chamber rotary valve developed by ETA, which has been and tried and tested for years, can easily handle wood chips up to P31S (formerly G50). The power requirement is minimal, the one-chamber rotary valve is driven by the same motor as the stoker screw.

**Rotary valve stop for a long service life:** The material transport always takes place in a stationary large volume rotor (dia. 180 mm). A contact-free material transport with the rotor blade ensures quiet, low-wear and safe operation. Only very long pieces of woods which stand above the rotor, are easily cut by a knife-sharp, hardened blade and counter-blade. Neither when filling nor emptying the rotor from the bottom does material come into contact.

**ETA info: The rotary valve stop functions like this** The discharge screw conveys the material from the store room into the drop chute upper section. From there the material falls into the one-chamber rotary valve. Meanwhile the screw remains open pointing upwards. Because during the filling process it does not continue to turn and is only half filled, fuel material that is compliant with the standard is not constantly cut off. No material remains lying on the sealing surfaces. Thus ensuring a long lifetime for the blade and sealing surfaces.

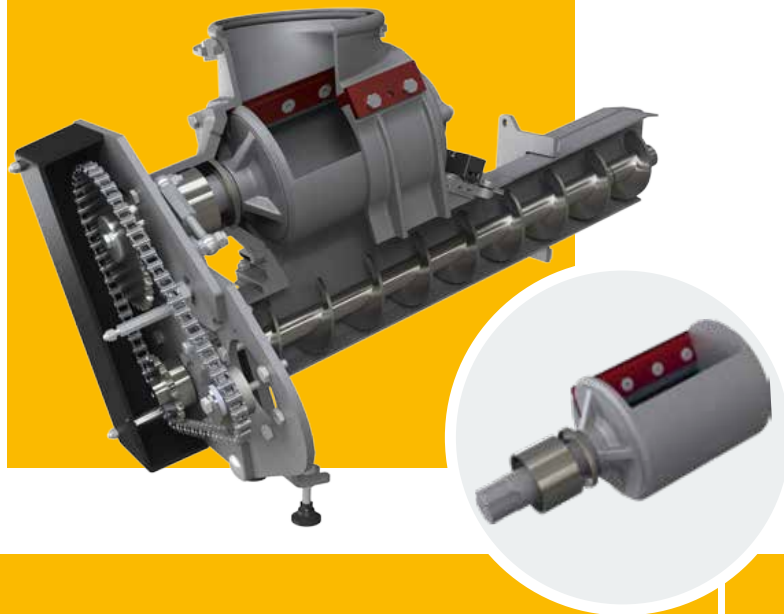

## Conventional double or multi-chamber rotary valve:

- larger power and energy requirement specially for coarse wood chips
- long pieces of wood bring the boiler to a standstill
- high wear
- noisy
- small sealing surfaces

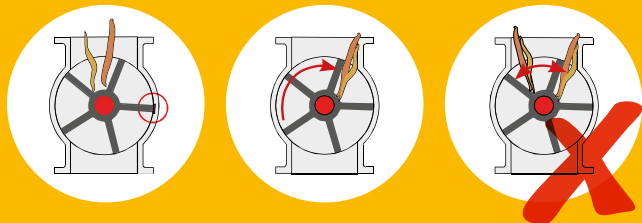

## ETA HACK one-chamber rotary valve

- low power and energy requirement also for coarse wood chips
- long parts are cut off with blades
- lower wear
- quiet
- large sealing area and thus the highest burn-back safety





## Intelligent technology in the combustion chamber

**Optimal fuel utilization.** The fuel is pushed from the side to the segment rotating grate in the combustion chamber and subjected to controlled burning there. The refractory-lined combustion chamber with controlled air flow enables a high combustion temperature and thus optimal fuel utilization. Once the material is completely burnt out, the segment grate turns a full 360°. Foreign bodies such as nails and stone safely fall through onto the ash screw which lies beneath. Through the patented rake above the combustion chamber, now the secondary combustion chamber is also de-ashed completely automatically, which increases the efficiency of the boiler and ensures lower flue gas temperatures at the same time.

**Overfill protection.** This is an important safety measure that ensures that no more fuel is in the chamber that could be combusted. Even if the boiler is cold or wet after a prolonged standstill, or a difficult-to-ignite fuel is used, overfilling of the boiler cannot happen, and thus deflagration is prevented. The sensor-controlled firebed control system always ensures the correct fuel quantity. This is an advantage for alternative fuels such as pellets, but also for very dry wood chips.



**Optimised ignition saves energy.** With short combustion breaks, the refractory-lined combustion chamber still remains hot enough that any new fuel which is fed in can be ignited by remaining embers. The noiseless ignition is only used after prolonged boiler standstills. The ignition fan is deactivated as soon as the lambda probe and exhaust temperature sensor signal that ignition was successful. That saves energy!

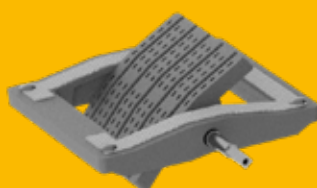

eHACK up to 80 kW

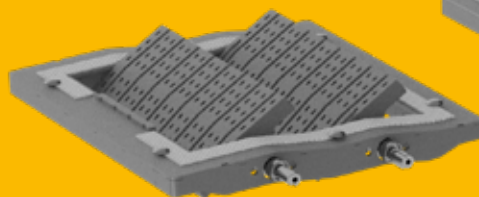

eHACK 100 - 170 kW

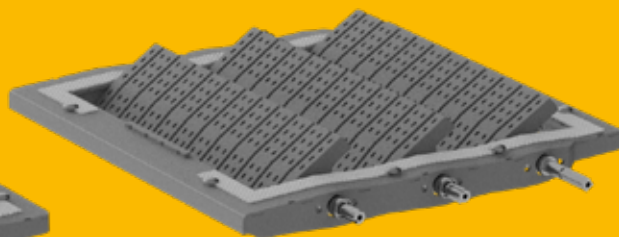

eHACK 180 - 240 kW

## Safely with negative pressure

**EC draught fan.** Quiet as a whisper, this speed-controlled fan ensures constant underpressure in the boiler. It works very economically thanks to EC motor technology. Additionally, the draught fan ensures oxygen supply in the combustion chamber and therefore for ideal burning behaviour and best utilisation of the fuel. Through the sophisticated boiler construction, the draught fan produces sufficient underpressure in the boiler, so that, contrary to conventional systems, no additional pressure fan is needed. The underpressure sensor provides for even more efficient control of the draught fan. This measures the negative pressure in the boiler and optimises the air supply in the combustion chamber. This minimises operating costs!



## Lambda probe

**It's all about the mix.** With help of the lambda probe, the mixing ratio of fuel and oxygen is perfectly coordinated, so different fuel qualities always achieve the best possible efficiency. In addition, the probe immediately detects if the ignition was successful. This reduces the ignition time and saves power and money.



*The lambda probe is an important part of the combustion technology. In conjunction with the ETA combustion control system, it determines the course and quality of combustion.*



## 7" touchscreen

A capacitive 16:9 format touchscreen with a robust and non-sensitive glass panel now also reacts without pressure making it's operation easier. The display can also be tilted for easier viewing.



## Integrated return riser

This ensures quick, space- and cost-saving assembly, as all components are checked and cabled at the factory. A pressure sensor to monitor the water pressure is already installed and an additional connection enables an optimum connection of the safety group.

## Optional precipitator

### Clever use of a natural phenomenon

Why does dust keep building up on the computer screen? It's because the dust particles are electrostatically charged and are attracted by the screen – ETA makes use of this effect in its precipitator. With the aid of an electrode in the flue gas duct the particles which are swirling in the flue gas are energised and ionised. This results in the particles being deposited on the internal wall of the separator and no longer escaping from the chimney with the flue gases.

The precipitator is cleaned completely automatically during de-ashing. The dust then lands in the front ash box along with the remaining ash from the boiler.

As the precipitator can be integrated into the eHack, nothing stands in the way of a retrofit and no additional space has to be planned in the boiler room.

With a degree of separation of 80-85%, even for poor fuel the precipitator ensures low dust emission at minimum power consumption.



# Cleanliness yields the highest efficiency

In ETA systems, the combustion chamber and heat exchanger are automatically cleaned as a whole. This increases the efficiency and minimises the maintenance effort for the boiler. Eventually the ash box must be emptied – thanks to ash compression and large volume of the ash box less frequently than with conventional systems.

## Automatic de-ashing: conclusively progressive

As the screw for de-ashing is about the same size as the stoker screw, foreign bodies such as stones or nails in the ash are no problem either. The screw can also easily be taken out from the front.

## Heat exchanger cleaning:

**permanently high efficiency.** A special dampened mechanism cleans the heat exchanger pipes and allows fly ash to fall down with a return movement. Even the optionally integrated precipitator uses this mechanism for its cleaning. That is clean and efficient! The falling ash is largely picked up from the boiler floor via a mini moving floor and fed to a screw placed in the centre.

*The patented rotary valve auger reliably seals the ash channel between the heat exchanger and the combustion chamber.*

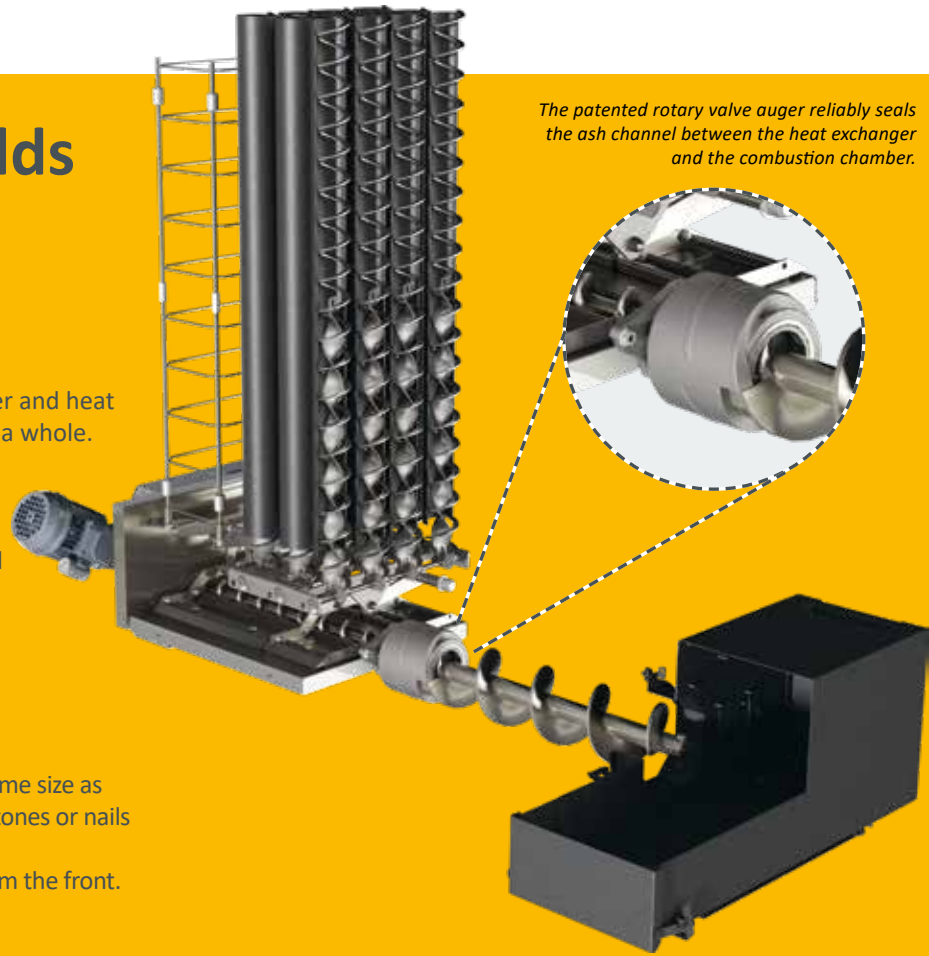

## Ash box: extra large, but practical to empty.

Ash is conveyed fully automatically into an external ash box. The de-ashing screw compresses the ash and extends the emptying interval significantly in comparison with other systems. The box is best transported with a handcart. A guide plate on the box ensures correct transport, even if it's uneven at times. For simplified discharge, the front cover with the robust lock can be completely removed. So when emptying, the box fits virtually all bins or containers.



## External de-ashing systems

To achieve even larger de-ashing intervals, ETA offers a de-ashing extension in external containers. The extension can be placed to the left or right of, as well as in front of or next to the boiler! Not only does this

system offer planning flexibility, it also saves a lot of space thanks to the specially designed coreless screw system.

### Ash bins with 240 l or 320 l capacity

#### 240 litres

The hot-galvanized steel container has wheels for easier removal, meets the requirements of EN 840, and is suitable for removal by a disposal company.



240 Liter

#### 320 litres

The flap located in the bottom of the container provides a convenient discharge. Using a pallet fork, the container can be transported with front loader or forklift.

The bottom flap is unlocked when the container is either on the wheels or is secured by suitable means. After unlocking, the container can be moved slowly upwards to gently open the flap and minimize the formation of dust.



320 Liter

# From store into the boiler

How should I design my store room? How to ensure the smooth transport of fuel from the store into the boiler? With the ETA systems you have the most varied of options.

## One agitator for all eventualities

The ETA agitator adapts to the structural conditions. Ideally there is a height difference between the

store room and the boiler room, so that the agitator can be mounted horizontal. With ETA even an inclined transportation is possible between store and boiler, because the feet under the agitator plate can be adjusted, allowing the inclination of the conveying system to be precisely set.



### ETA-Tipp:

#### Rule of thumb for wood chip requirements

35 kW x 2 for good wood chips = 70 tcm/year

35 kW x 3 for poor wood chips = 105 tcm/year

For a horizontal discharge a height difference of 690 mm between storage room and boiler room is necessary.



### ETA info: Planning advice for a wood chip store

- The floor agitators are designed for a maximum wood chip fill height of 5 m.
- The trough screw between store outlet and boiler may be a maximum of 6 metres (L) long.



### With or without tilted floor?

Without a tilted floor the installation of the floor agitator is easier. You can also rely on quiet operation. However, a small part of the store cannot be emptied fully automatically. This is simply filled with very dry wood chips during the first load. If you decide on an inclined tilting floor, fewer wood chips remain in the store.





# From the store into the boiler

A good wood chip boiler needs no maintenance, the fuel transport functions fully automatically. The ETA discharge system ensures that this also works smoothly and without blockages for coarse wood chips.

*The universal joint ensures that the motor can change direction to loosen blockages in the transport screw, without the floor agitator also rotating in the wrong direction.*



## Easy also for large pieces

With the ETA eHack you can also burn coarse wood chips (P31S/G50). The ETA discharge system easily transports pieces with a length of up to 15 cm. Special progressive screws are responsible for the smooth transport from the store into the boiler. So that there are no stoppages – above all in the transition from the open trough in the store to the closed trough outside - the distance between the individual windings of the transport screw is increased. This loosens the material and a quiet, smooth, power-saving material flow is guaranteed.

No standstill, it does jam up. If a material jam still occurs, the flow monitor notes this immediately in the control system and moves the screws in the other direction until the material has come loose and the fuel transport can proceed unhindered. To make sure the flat spring arms are not damaged, the agitator may not move in the counter-direction at the same time. The universal joint ensures this: If the screws move backwards, the floor agitator is automatically decoupled from the motor.

*Strong flat spring arms from 1.5 m to 4.0 m*

*Massive articulated arm or double hinge arm technology from 4.5 m to 6.0 m*

## Always optimum fuel pick-up

Floor agitators with strong flat spring arms for store rooms between 1.5 and 4 metres diameter, each made to fit in half-metre steps. For rooms of 4 to 6 metres, ETA offers articulated arm technology with a specially reinforced agitator

## The flexible system

For connecting screws, any length is possible up to six metres with standard parts – and in 125 mm intervals. The parts do not need to be welded or cut, but just plugged together.

*No on-site welding and cutting: The parts of the discharge systems are simply plugged together as needed.*

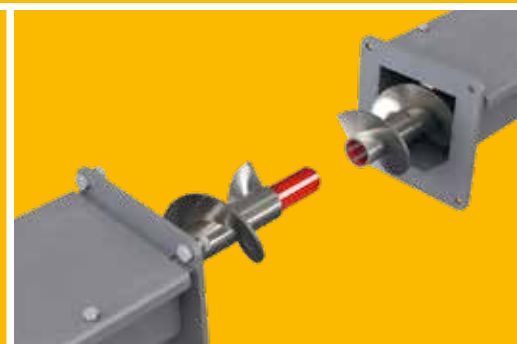



## The way to heat

From the storage room to the transport system into the combustion chamber: the interplay of high quality and flexible components according to the room situation is needed!

- 1 **Floor agitator:** Depending on storage room size, a floor agitator with a diameter of 1.5 m - 4 m can be used, with flat spring arms, or at 4.5 m - 6.0 m with articulated arms.
- 2 **Universal joint:** If the screw turns backwards due to blockages in the fuel supply, the joint decouples the agitator plate from the screw and thus protects the flat spring arms.
- 3 **Open trough:** Thanks to the generous trough cross-section, the progressive screw and the special trough geometry, even coarse wood chips are conveyed quietly, with little wear and in an energy-saving way.
- 4 **Flexible building block system:** The fuel discharge can be flexibly arranged depending on room situation. Installation is quick and easy, the components don't have to be cut or welded, as they can simply be connected with the friction-locked PTO profiles.
- 5 **Spur gear motors:** They drive the whole transport system including the agitator. Thanks to active power monitoring, the control system immediately detects if too much force is applied to the transport, i.e. if a blockage has occurred somewhere in the system. Then the direction of rotation of the screw is changed up to three times to loosen the material.
- 6 **Ball joint connection to drop chute:** It ensures a flexible connection between transport system and boiler. The inclination and angle can be flexibly adapted to the structural situation. A built-in seal ensures clean operation without dust escaping.
- 7 **One-chamber rotary valve:** It reliably prevents burn-back and thus ensures the highest safety. With a diameter of 18 cm, it has a large chamber that is only filled at standstill thanks to the automatic rotary valve stop. That is why it works especially efficiently, in an energy-saving and low-wear manner. It is driven together with the stoker screw. A hardened blade with counter-blade reliably cuts off oversized fuel parts, so nothing gets jammed.
- 8 **Rising stoker screw:** Thanks to its large diameter, it even transports coarse material into the combustion chamber without resistance.
- 9 **Touch control system with microprocessors:** With just a few swipes of your finger you intuitively control the whole menu. If your boiler is connected to the internet, it tells you by email when the ash box has to be emptied, for example. In addition, you can use the free communication platform meinETA with partner network as well as free software updates via USB connection.



**10 Draught fan:** Quiet as a whisper, this fan ensures underpressure in the boiler. Additionally, it controls the air quantity and thus ensures safety in the boiler room. In contrast with conventional systems, no additional pressure blower is required. That saves energy!

**11 Heat exchanger cleaning:** The heat exchanger is completely cleaned with turbulators automatically. This ensures consistently high efficiency.

**12 Primary and secondary air valves:** Both flaps are controlled via the lambda probe so that the ideal amount of air for combustion reaches the combustion chamber at all times.

**13 Hot combustion chamber:** To fully free the combustion chamber of ash, the grate automatically tilts at an angle of over 360° so that the ash can fall down smoothly. Therefore the operation is not impaired by foreign bodies in the ash, for example stones or nails.

**14 Fully automated de-ashing in an external ash box:** The ash is transported out of the combustion chamber, heat exchanger and the optional precipitator to the ash box via the ash screw and compressed there. This ensures long de-ashing intervals and comfort.

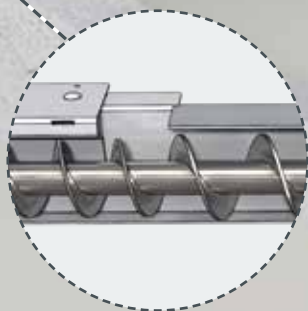
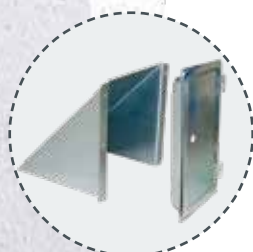
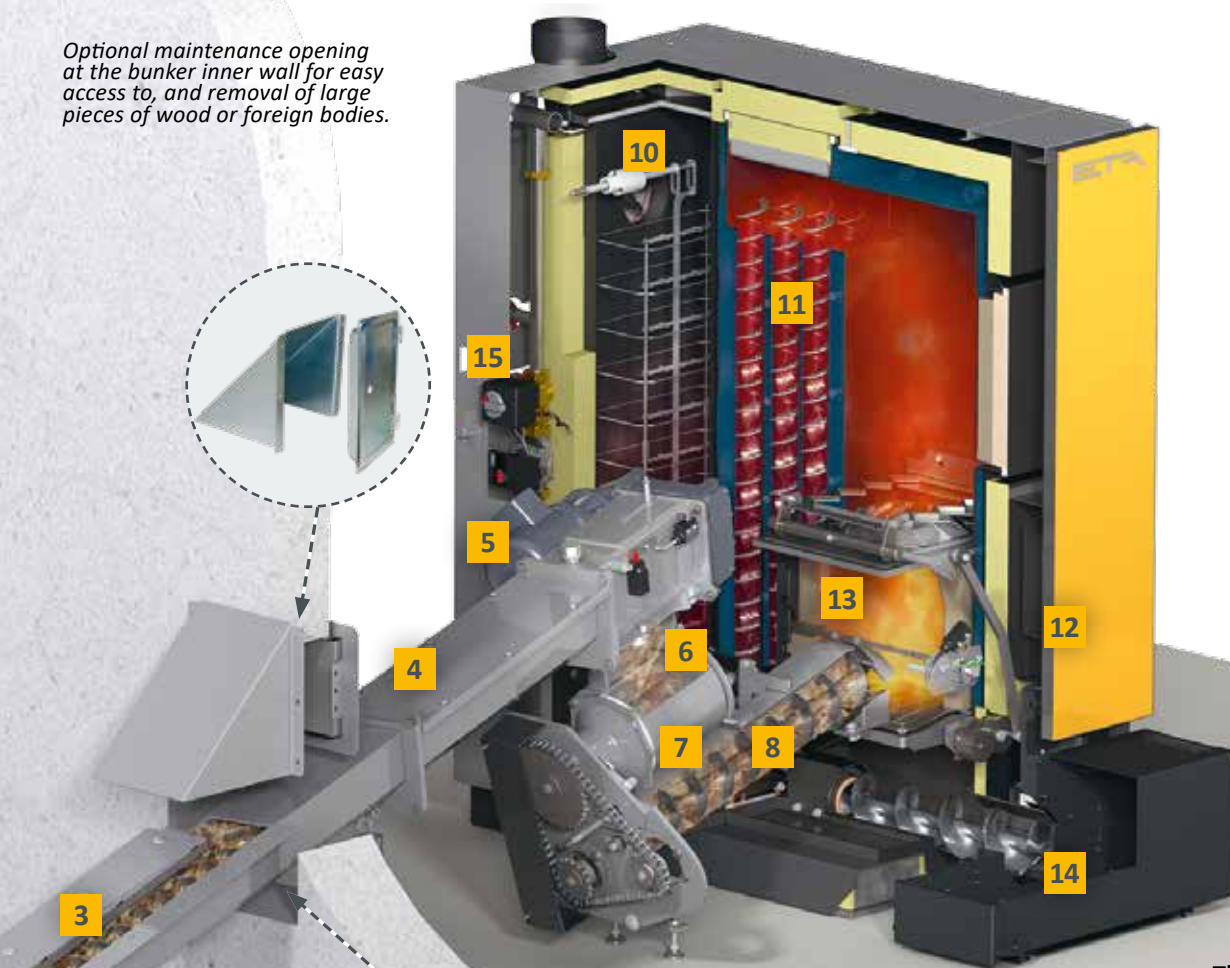

**15 Integrated return riser:** ensures a quick, space- and cost-saving installation.

*Optional maintenance opening at the bunker inner wall for easy access to, and removal of large pieces of wood or foreign bodies.*



**Progressive screw:**  
*Through the change of pitch and diameter the material is transported quietly, with low-wear and in an energy-saving way.*

**The way through the boiler:**

-  Fuel
-  Flue gases
-  Heating water

# Special solutions as required

With our modular system, we are able to build a technically perfect conveying system with a very good price-performance ratio for almost all situations.

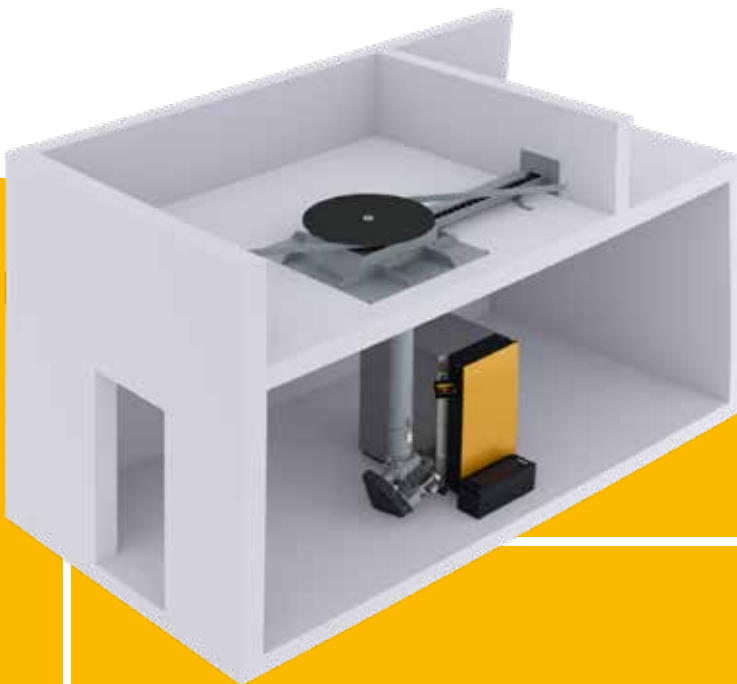

## Centred outlet agitator

A centred outlet agitator ensures the wood chip store is discharged directly above the boiler room.

## Intermediate conveyor screw

You can use intermediate conveyor screws to overcome height differences, direction changes, and distances up to 6 m. These should not be installed with inclinations greater than 30°. We also use intermediate conveyor screws to form connections to existing storeroom conveying systems.



## Double screw agitator

Two boilers on a single agitator. The agitator has a drive which is controlled by one or both boilers. This design offers the advantage of a uniform discharge of the storeroom regardless of the running times of the two boilers.

### Double agitator

Conveying systems from rectangular rooms can be realized with two agitators and an intermediate conveyor screw.



## The solution for pellet heaters

If there is little space for a wood chip store, pellets are the ideal solution, as the energy density of pellets is about four times as high as that of wood chips. So for the same heating performance you only need a quarter of the storage space.

### Planning advice for a pellet store with agitator

- Pellets are much heavier than wood chips. That is why agitators may only be filled with pellets up to a height of 2 metres.
- To ensure that the pellets are not damaged, only flat-spring agitators up to max. 4 metres in diameter may be used, and the angle of inclination may not exceed 12°.
- A special cover plate for pellets is needed on the open trough screw in the store.
- The trough screw between store outlet and boiler may be a maximum of 1.5 metres long.

### Those who want to operate their boiler with pellets only...

... should rely on the discharge screws specially developed by ETA for the transport of pellet fuel. Additionally, the fuel can also be heaped up significantly higher thanks to the ETA discharge screw.



### A numbers game

A system with 45 kW heating load annually consumes about 15 tonnes of pellets, that corresponds to a size of 23 cubic metres.

For annual filling, including reserves, a storage room volume of just 30 m<sup>3</sup> is sufficient.

#### Provides a storeroom size of:

- 4 x 4 m agitator (max. 2 m fill height)
- 2 x 5 m screw (at 4.5 m fill height)

### Planning advice for pellet store with discharge screw:

- The open trough screw in the store room may be a maximum of six metres long, the total length of the open and closed trough screws may be a maximum of eight metres.
- Taking into consideration the structural integrity of the building, the screws can be filled up to six metres high.



## Store filling: simple, safe, clean

Particularly when heating with wood chips, a well thought out solution for how the store is filled is important, because this saves money and avoids frustration over many years.



### Filling at ground level

This form of storage is the classic one used on farms or in businesses. It is the most economical and simplest way to store wood chips. If devices such as front-end loaders, dumpers or push-off trailers are available, they are even better to use. Also the work and time expended when filling is reduced to a minimum. With large volume transport units such as dumpers or push-off trailers, the material is directly unloaded onto the discharge system.

ETA discharge systems allow extremely large fill heights. With a front end loader or telescopic loader the wood chips are just suspended.

### ETA tip: Collision protection

It protects against accidental damage to the agitator during filling.

### Dumping into a store below access level

To achieve a good fill even with a steep angle of repose for wood chips, the shaft opening should be large. In the best case, it is 2 m wide and extends across the entire diameter of the store. Store diameters up to 6 m are possible with this system. To prevent bridging, the agitator diameter chosen should never be less than the store diameter. If a new storage room is to be built, the best solution is an economical round layout that can be realised with typical manure pit formwork. That is especially economical.





**Bunker filling screw or filling nozzle for cellar rooms**

This solution is ideal if you want to use existing rooms or have your wood chip system directly in the house. Bunker filling screws can be very flexibly installed at an angle to the room's axis or also inclined and are continuously adjustable up to 45°. Here, floor agitator diameters up to 6 m are

possible. For room heights less than half the agitator diameter, we recommend two screws to be able to optimally fill the store room.

If the building layout does not allow a filling hopper or access to the wood chip transporter is difficult, wood chips can be fed from the tanker via a filling nozzle. If only pellets are to be used, filling nozzles are the best solution.

**ETA extra: better safe than sorry**

All open filling troughs have a protective screen. This not only protects against accidents when the screw is running, but also ensures the smooth transport of the wood chips without jamming thanks to the jogging motor.

**Vertical screw and centrifuge for high store rooms**

This solution is suitable for coarse wood chips with a small fine portion, but not for pellets. It is used for high store rooms, so for example when the boiler room is integrated into high rooms or there is little area available. With the vertical transport screw wood chips can be conveyed up to 8 metres high. In order for the centrifuge to eject the wood chips widely and optimally in the store room, the ratio of fine material may not be too high.



**Vertical screw with filling screw**

As with the filling system that utilises a centrifuge, the wood chips are conveyed vertically up to 8 m. The material is then transported into the storeroom with another screw. This variant uses the space beneath the roof slope very well.



# ETA eHACK 20 to 50 kW

- 1** Connection for safety valve, pressure gauge and bleed valve R1/2" internal thread
- 2** Flow, 5/4" ball valve
- 3** Return, 5/4" ball valve
- 4** Filling and draining valve

The boiler can optionally be supplied with the stoker on either the right or the left side.

Optimum maintenance area. Fixed components (e.g. expansion tank, hot water tank) in this area may require more cleaning and maintenance. The dimensions marked with an asterisk symbol (\*) indicate the minimum dimensions for the maintenance area.

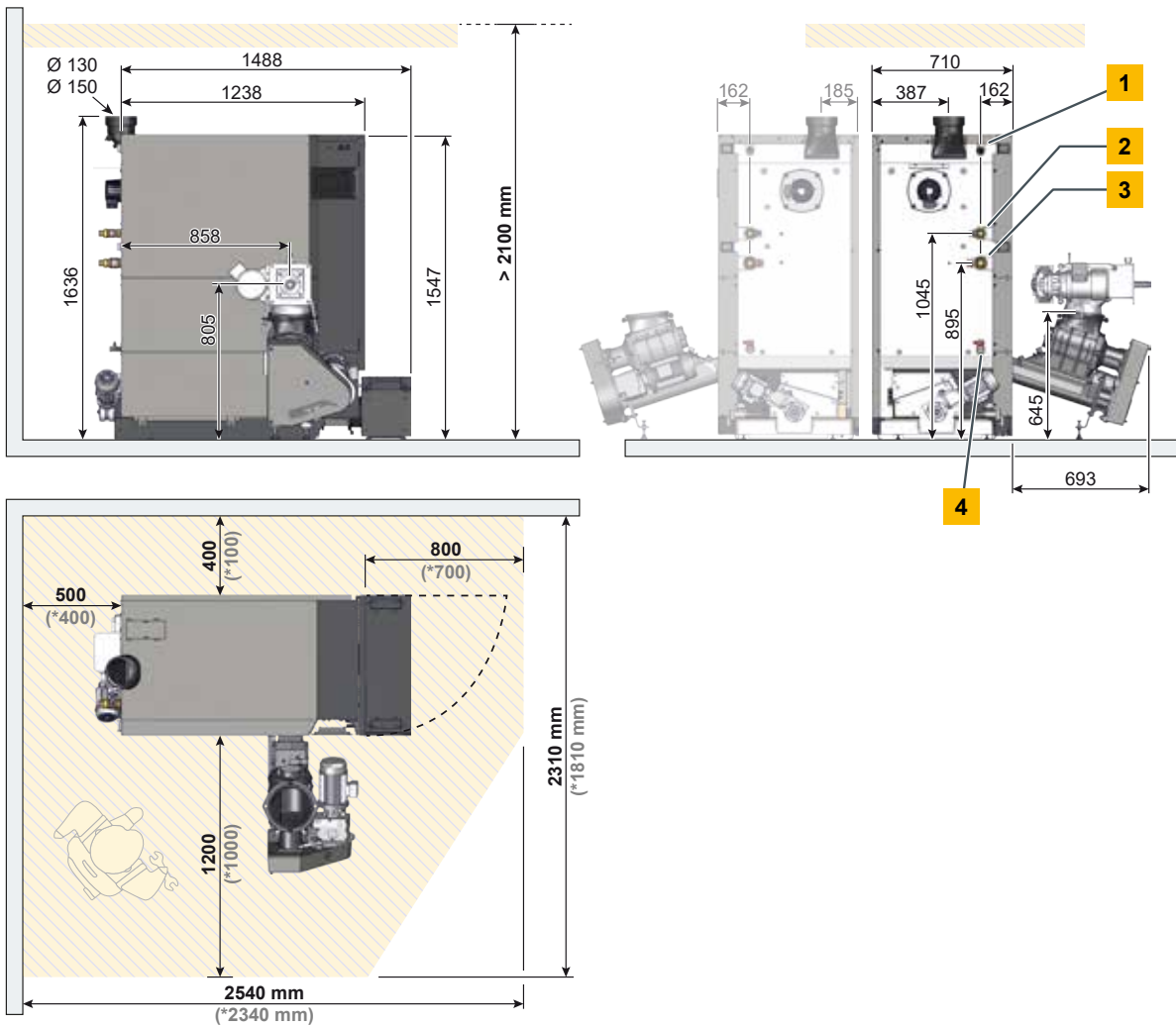





wood chip boiler eHACK		20	25	32	45	50
Rated capacity. wood chips <sup>[a]</sup>	kW	5.9 - 19.9	7.6 - 25.4	7.6 - 32	7.6 - 45	14.9 - 49.9
Rated capacity. pellets	kW	-	7.6 - 25.4	7.6 - 32	7.6 - 45	14.9 - 49.9
Energy efficiency class „package-system“		A+	A++	A++	A++	A++
Efficiency with wood chips at partial / full load	%	91.2 / 94.0	94.7 / 94.8	94.7 / 94.8	94.7 / 94.7	94.8 / 94.7
Efficiency with pellets at partial / full load	%	-	93.4 / 94.6	93.4 / 94.3	93.4 / 93.7	93.4 / 93.6
Transport dimensions. W x D x H	mm	710 x 1430 x 1610				
Weight with / without rotary valve stoker	kg	830 / 712				
Water content	litres	153				
Available residual pump head (at $\Delta T = 20\text{ }^{\circ}\text{C}$ ) for buffer operation	mWs / m <sup>3</sup> /h	5.5 / 0.86	5.2 / 1.08	4.1 / 1.38	2.8 / 1.92	2.0 / 2.13
Ash box volume	litres	52				
Required flue draught A draught limiter is recommended above 25 Pa. If the boiler is operated with flue gas recirculation, a draught limiter must be installed ( $\leq 15\text{ Pa}$ ).	Pa	>5				
Electrical power consumption with wood chips at partial / full load (=values with integrated precipitator)	W	52 / 74 (72 / 94)	56 / 83 (76 / 103)	56 / 94 (76 / 114)	56 / 121 (76 / 141)	57 / 124 (87 / 154)
Electrical power consumption with pellets at partial / full load (=values with integrated precipitator)	W	- (-)	44 / 63 (64 / 83)	44 / 71 (64 / 91)	44 / 84 (64 / 104)	46 / 92 (76 / 122)
Electrical power consumption in standby	W	12				
Maximum permissible operating pressure	bar	3				
Temperature adjustment range	$^{\circ}\text{C}$	70 – 85				
Maximum permissible operating temperature	$^{\circ}\text{C}$	85				
Boiler class		5 according to EN 303-5				
Suitable fuels		Wood chips EN ISO 17225-4. P16S-P31S (G30-G50). maximum 35% water content; pellets EN ISO 17225-2-A1. ENplus-A1				
Electrical connection		400 V AC / 50 Hz / 16 A / 3P+N+PE				

<sup>[a]</sup> Type used: M25 BD 150 (W25-S160)

Subject to technical changes and errors

Complies with  
EU standards



Austrian Ecolabel



# ETA eHACK 60 to 80 kW

- 1** Connection for safety valve, pressure gauge and bleed valve R3/4" internal thread
- 2** Flow, 6/4" ball valve

- 3** Return, 6/4" ball valve
- 4** Filling and draining valve

The boiler can optionally be supplied with the stoker on either the right or the left side.

Optimum maintenance area. Fixed components (e.g. expansion tank, hot water tank) in this area may require more cleaning and maintenance. The dimensions marked with an asterisk symbol (\*) indicate the minimum dimensions for the maintenance area.

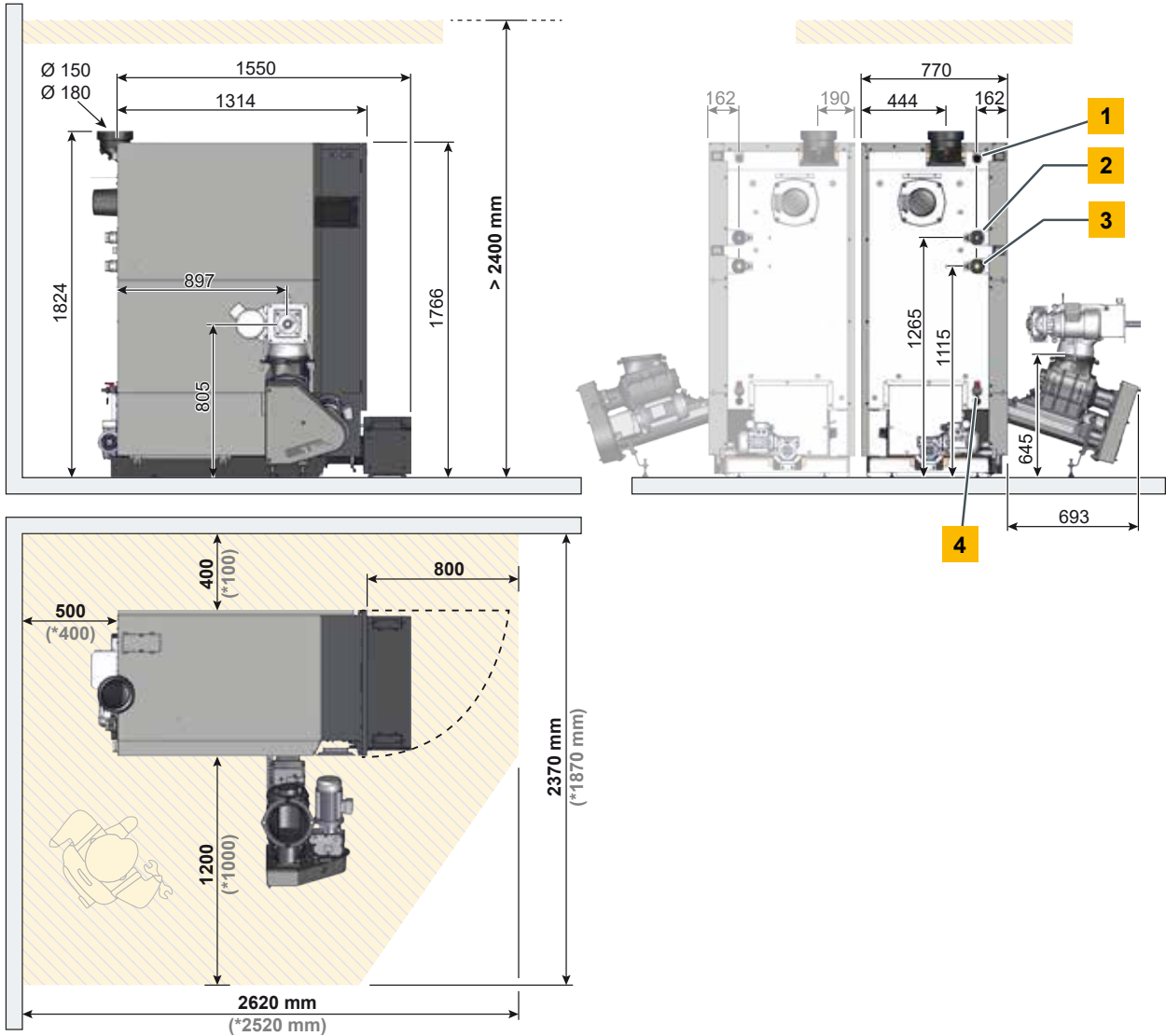



wood chip boiler eHACK		60	70	80
Rated capacity . wood chips <sup>[a]</sup>	kW	17.9 - 59.9	20.9 - 69.9	23.2 - 79.9
Rated capacity . pellets	kW	17.9 - 59.9	20.9 - 69.9	23.2 - 85
Energy efficiency class „package-system“		A++	A++	-
Efficiency with wood chips at partial / full load	%	95.1 / 94.7	95.4 / 94.6	95.7 / 94.6
Efficiency with pellets at partial / full load	%	93.4 / 93.5	93.3 / 93.3	93.3 / 93.1
Transport dimensions . W x D x H	mm	770 x 1455 x 1826		
Weight with / without rotary valve stoker	kg	1110 / 992		
Water content	litres	203		
Available residual pump head (at $\Delta T = 20\text{ }^{\circ}\text{C}$ ) for buffer operation	mWs / m <sup>3</sup> /h	4.5 / 2.6	3.7 / 3	2.5 / 3.4
Ash box volume	litres	52		
Required flue draught A draught limiter is recommended above 25 Pa. If the boiler is operated with flue gas recirculation . a draught limiter must be installed ( $\leq 15$ Pa).	Pa	>5		
Electrical power consumption with wood chips at partial / full load (=values with integrated precipitator)	W	63 / 145 (93 / 175)		
Electrical power consumption with pellets at partial / full load (=values with integrated precipitator)	W	59 / 140 (89 / 170)		
Electrical power consumption in standby	W	15		
Maximum permissible operating pressure	bar	3		
Temperature adjustment range	$^{\circ}\text{C}$	70 – 85		
Maximum permissible operating temperature	$^{\circ}\text{C}$	85		
Boiler class		5 according to EN 303-5		
Suitable fuels		Wood chips EN ISO 17225-4 . P16S-P31S (G30-G50) . maximum 35% water content; pellets EN ISO 17225-2-A1 . ENplus-A1		
Electrical connection		400 V AC / 50 Hz / 16 A / 3P+N+PE		

<sup>[a]</sup> Type used: M25 BD 150 (W25-S160)

Subject to technical changes and errors

Complies with  
EU standards



Austrian Ecolabel



# ETA eHACK 100 to 130 kW

- 1** Connection for safety valve, pressure gauge and bleed valve, R1"
- 2** Flow, 2" ball valve
- 3** Return, 2" ball valve

- 4** Filling and draining valve
- 5** Safety heat exchanger R1/2"

The boiler can optionally be supplied with the stoker on either the right or the left side.

Optimum maintenance area. Fixed components (e.g. expansion tank, hot water tank) in this area may require more cleaning and maintenance. The dimensions marked with an asterisk symbol (\*) indicate the minimum dimensions for the maintenance area.

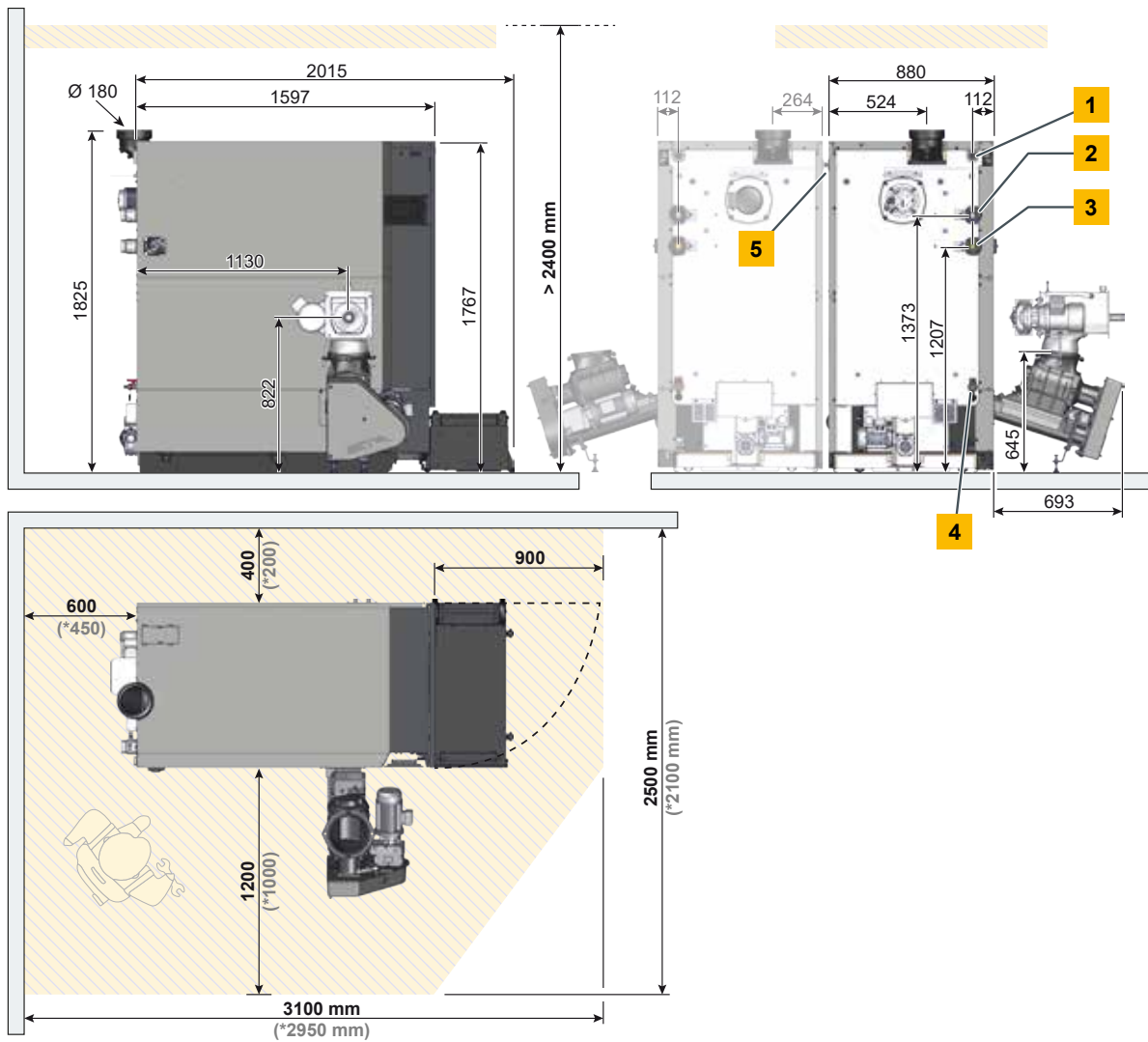



wood chip boiler eHACK		100	110	120	130
Rated capacity, wood chips <sup>[a]</sup>	kW	29.9 - 99.9	32.9 - 109.9	35.9 - 119.9	38.6 - 128.9
Rated capacity, pellets	kW	29.9 - 99.9	32.9 - 109.9	35.9 - 119.9	38.9 - 129.9
Efficiency with wood chips at partial / full load	%	95.2 / 93.8	94.9 / 93.4	94.6 / 93	94.8 / 93.3
Efficiency with pellets at partial / full load	%	92.7 / 93	92.4 / 93	92 / 92.9	92.3 / 93.1
Transport dimensions. W x D x H	mm	922 x 1764 x 1825			
Weight with / without rotary valve stoker	kg	1447 / 1329			
Water content	litres	272			
Available residual pump head (at $\Delta T = 20\text{ }^{\circ}\text{C}$ ) for buffer operation	mWs / m <sup>3</sup> /h	4.5 / 4.3	3.8 / 4.7	3.1 / 5.1	2.5 / 5.5
Ash box volume	litres	94			
Required flue draught A draught limiter is always required ( $\leq 15\text{ Pa}$ )	Pa	> 5			
Electrical power consumption with wood chips at partial / full load (=values with integrated precipitator)	W	53 / 176 (152 / 263)			
Electrical power consumption with pellets at partial / full load (=values with integrated precipitator)	W	49 / 124 (148 / 211)			
Electrical power consumption in standby	W	13			
Maximum permissible operating pressure	bar	3			
Temperature adjustment range	$^{\circ}\text{C}$	70 – 90			
Maximum permissible operating temperature	$^{\circ}\text{C}$	90			
Boiler class		5 according to EN 303-5			
Suitable fuels		Wood chips EN ISO 17225-4. P16S-P31S (G30-G50). maximum 35% water content; pellets EN ISO 17225-2-A1. ENplus-A1			
Electrical connection		400 V AC / 50 Hz / 16 A / 3P+N+PE			

<sup>[a]</sup> Type used: M25 BD 150 (W25-S160)

Subject to technical changes and errors

Complies with  
EU standards



Austrian Ecolabel



# ETA eHACK 140 to 170 kW

- 1** Connection for safety valve, pressure gauge and bleed valve, R1"
- 2** Flow, 2" ball valve
- 3** Return, 2" ball valve

- 4** Filling and draining valve
- 5** Safety heat exchanger R1/2"

The boiler can optionally be supplied with the stoker on either the right or the left side.

Optimum maintenance area. Fixed components (e.g. expansion tank, hot water tank) in this area may require more cleaning and maintenance. The dimensions marked with an asterisk symbol (\*) indicate the minimum dimensions for the maintenance area.

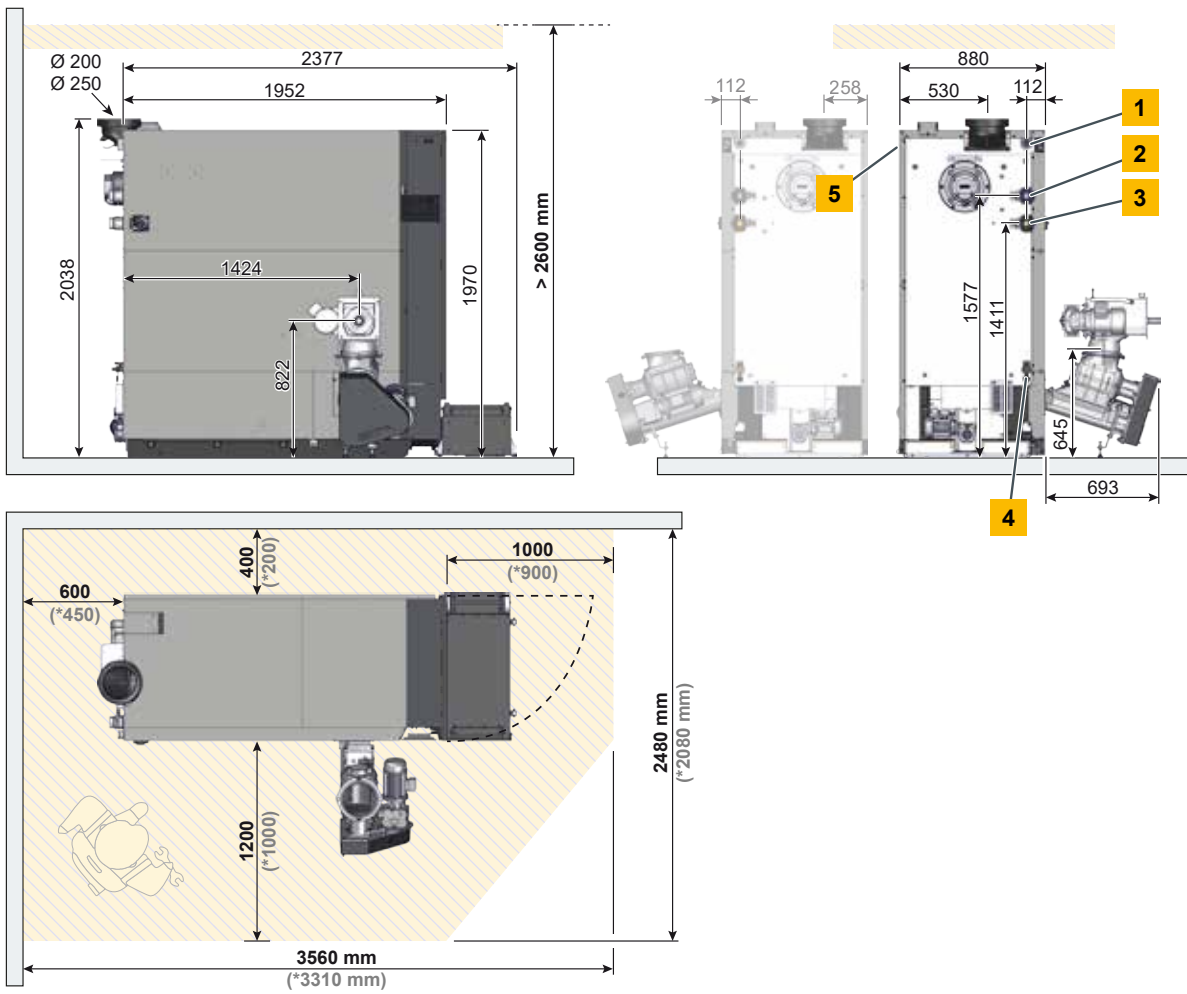



wood chip boiler eHACK		140	150	160	170
Rated capacity, wood chips <sup>[a]</sup>	kW	41.9 - 139.9	44.9 - 149.9	47.9 - 159.9	50.9 - 169.9
Rated capacity, pellets	kW	41.9 - 139.9	44.9 - 149.9	47.9 - 159.9	50.9 - 169.9
Efficiency with wood chips at partial / full load	%	95.1 / 93.6	95.4 / 93.8	95.6 / 94.1	95.9 / 94.4
Efficiency with pellets at partial / full load	%	92.8 / 93.4	93.1 / 93.6	93.5 / 93.9	93.9 / 94.1
Transport dimensions. W x D x H	mm	905 x 2073 x 1970			
Weight with / without rotary valve stoker	kg	1800 / 1682			
Water content	litres	347			
Available residual pump head (at $\Delta T = 20\text{ }^{\circ}\text{C}$ ) for buffer operation	mWs / m <sup>3</sup> /h	4.8 / 6	4.2 / 6.4	3.4 / 6.8	2.7 / 7.2
Ash box volume	litres	94			
Required flue draught A draught limiter is always required ( $\leq 15\text{ Pa}$ )	Pa	> 5			
Electrical power consumption with wood chips at partial / full load (=values with integrated precipitator)	W	80 / 201 (179 / 288)			
Electrical power consumption with pellets at partial / full load (=values with integrated precipitator)	W	76 / 149 (175 / 236)			
Electrical power consumption in standby	W	15			
Maximum permissible operating pressure	bar	3			
Temperature adjustment range	$^{\circ}\text{C}$	70 – 90			
Maximum permissible operating temperature	$^{\circ}\text{C}$	90			
Boiler class		5 according to EN 303-5			
Suitable fuels		Wood chips EN ISO 17225-4. P16S-P31S (G30-G50). maximum 35% water content; pellets EN ISO 17225-2-A1. ENplus-A1			
Electrical connection		400 V AC / 50 Hz / 16 A / 3P+N+PE			

<sup>[a]</sup> Type used: M25 BD 150 (W25-S160)

Subject to technical changes and errors

Complies with  
EU standards



Austrian Ecolabel



# ETA eHACK 180 to 240 kW

- 1** Connection for safety valve, pressure gauge and bleed valve, R5/4"
- 2** Flow, 2" ball valve
- 3** Return, 2" ball valve

- 4** Filling and draining valve
- 5** Safety heat exchanger R1/2"

The boiler can optionally be supplied with the stoker on either the right or the left side.

Optimum maintenance area. Fixed components (e.g. expansion tank, hot water tank) in this area may require more cleaning and maintenance. The dimensions marked with an asterisk symbol (\*) indicate the minimum dimensions for the maintenance area.

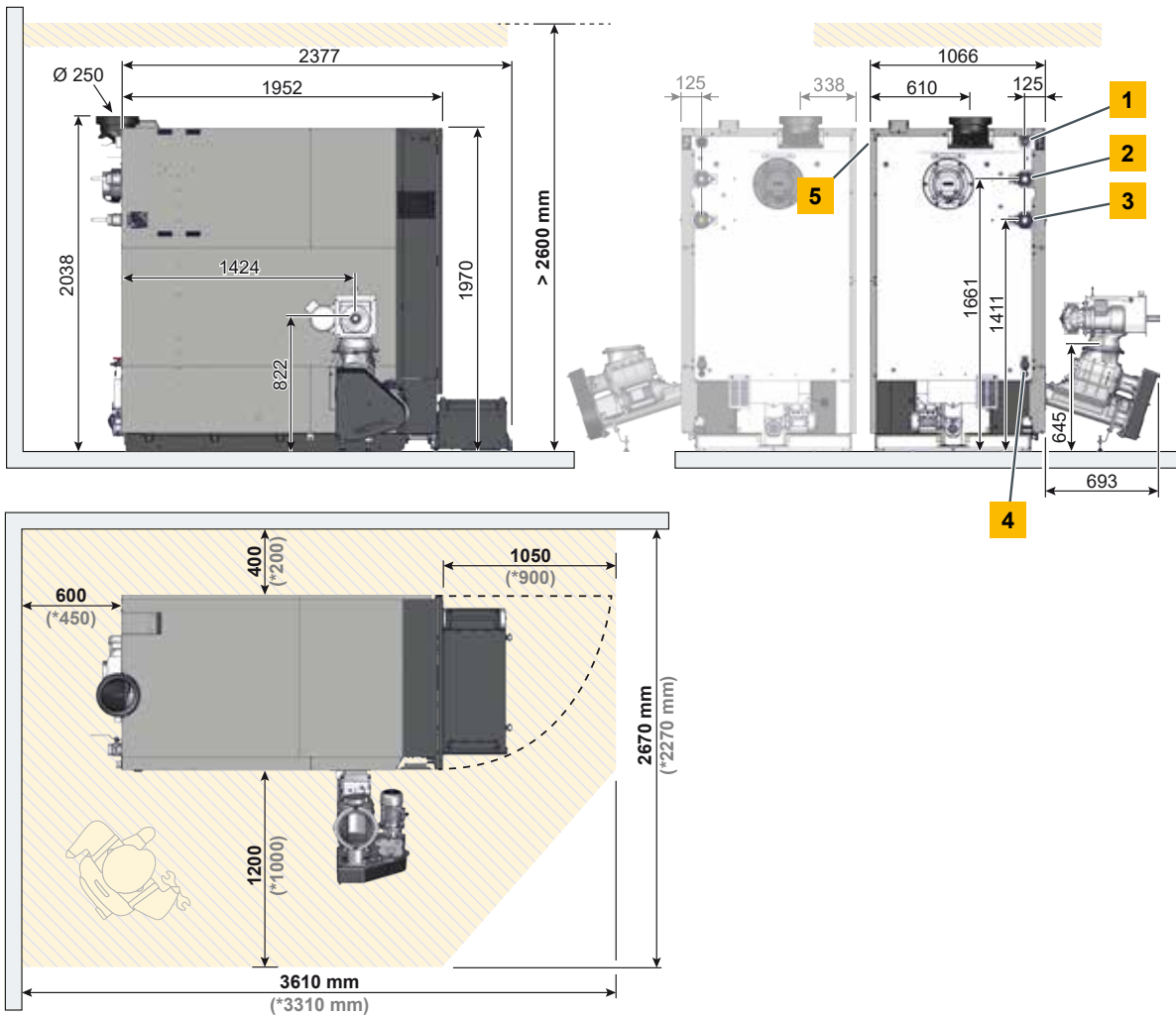





wood chip boiler eHACK		180	200	220	240
Rated capacity, wood chips <sup>[a]</sup>	kW	53.9 - 179.9	59.9 - 199.9	65.9 - 219.9	71.4 - 238
Rated capacity, pellets	kW	53.9 - 179.9	59.9 - 199.9	65.9 - 219.9	71.9 - 239.9
Efficiency with wood chips at partial / full load	%	96.1 / 94.7	96.6 / 95.2	97.1 / 95.8	97.6 / 96.3
Efficiency with pellets at partial / full load	%	94.3 / 94.4	95 / 94.9	95.8 / 95.4	96.5 / 95.8
Transport dimensions, W x D x H	mm	1076 x 2073 x 1970			
Weight with / without rotary valve stoker	kg	2100 / 1982			
Water content	litres	434			
Available residual pump head (at $\Delta T = 20\text{ }^{\circ}\text{C}$ ) for buffer operation	mWs / m <sup>3</sup> /h	6.5 / 7.7	5.5 / 8.5	4 / 9.4	2.5 / 10.2
Ash box volume	litres	94			
Required flue draught A draught limiter is always required ( $\leq 15\text{ Pa}$ )	Pa	> 5			
Electrical power consumption with wood chips at partial / full load (=values with integrated precipitator)	W	126 / 473 (390 / 743)			
Electrical power consumption with pellets at partial / full load (=values with integrated precipitator)	W	78 / 227 (358 / 487)			
Electrical power consumption in standby	W	17			
Maximum permissible operating pressure	bar	3			
Temperature adjustment range	$^{\circ}\text{C}$	70 – 90			
Maximum permissible operating temperature	$^{\circ}\text{C}$	90			
Boiler class		5 according to EN 303-5			
Suitable fuels		Wood chips EN ISO 17225-4, P16S-P31S (G30-G50), maximum 35% water content; pellets EN ISO 17225-2-A1, ENplus-A1			
Electrical connection		400 V AC / 50 Hz / 16 A / 3P+N+PE			

<sup>[a]</sup> Type used: M25 BD 150 (W25-S160)

Subject to technical changes and errors

Complies with  
EU standards



Austrian Ecolabel



# NOTES

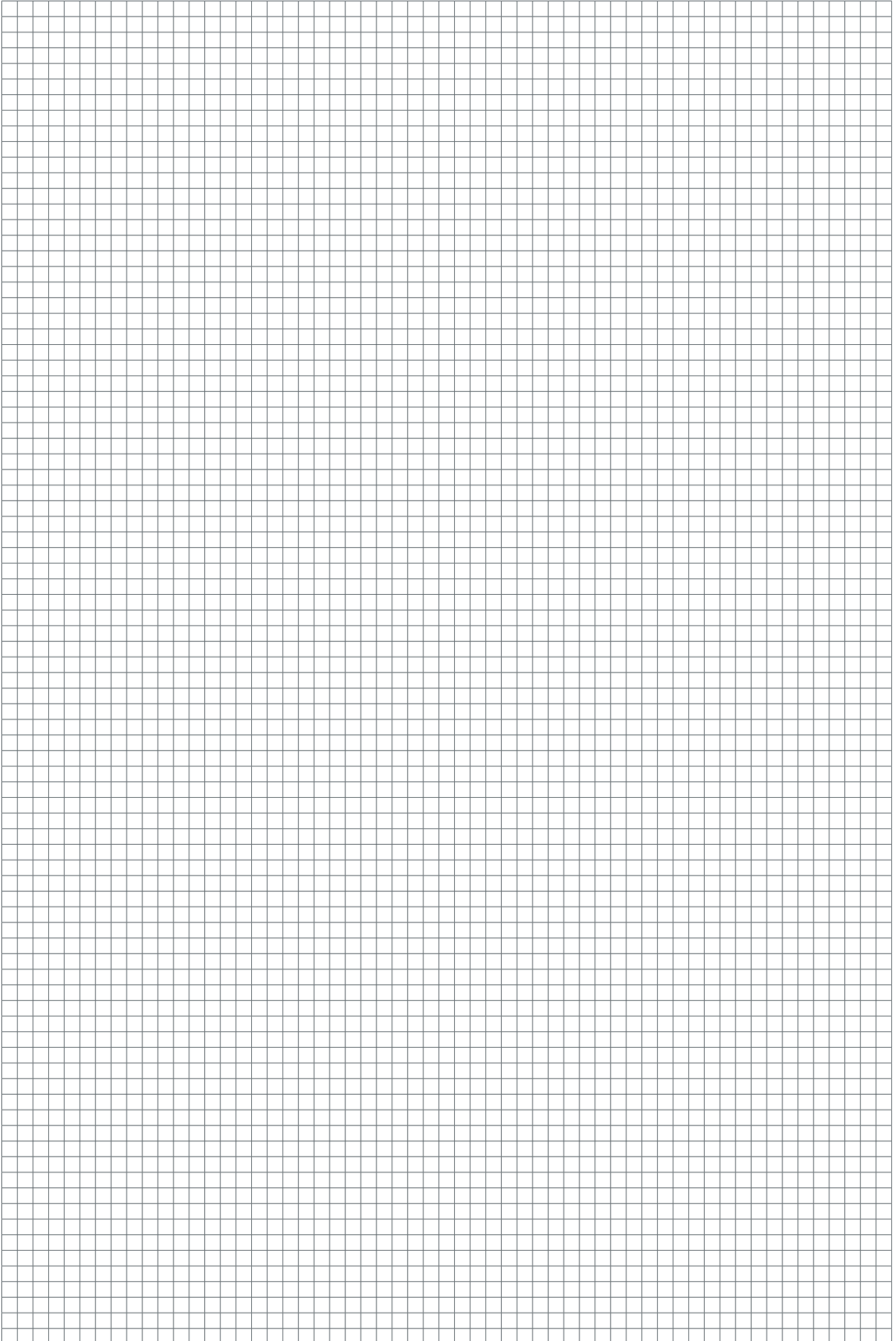

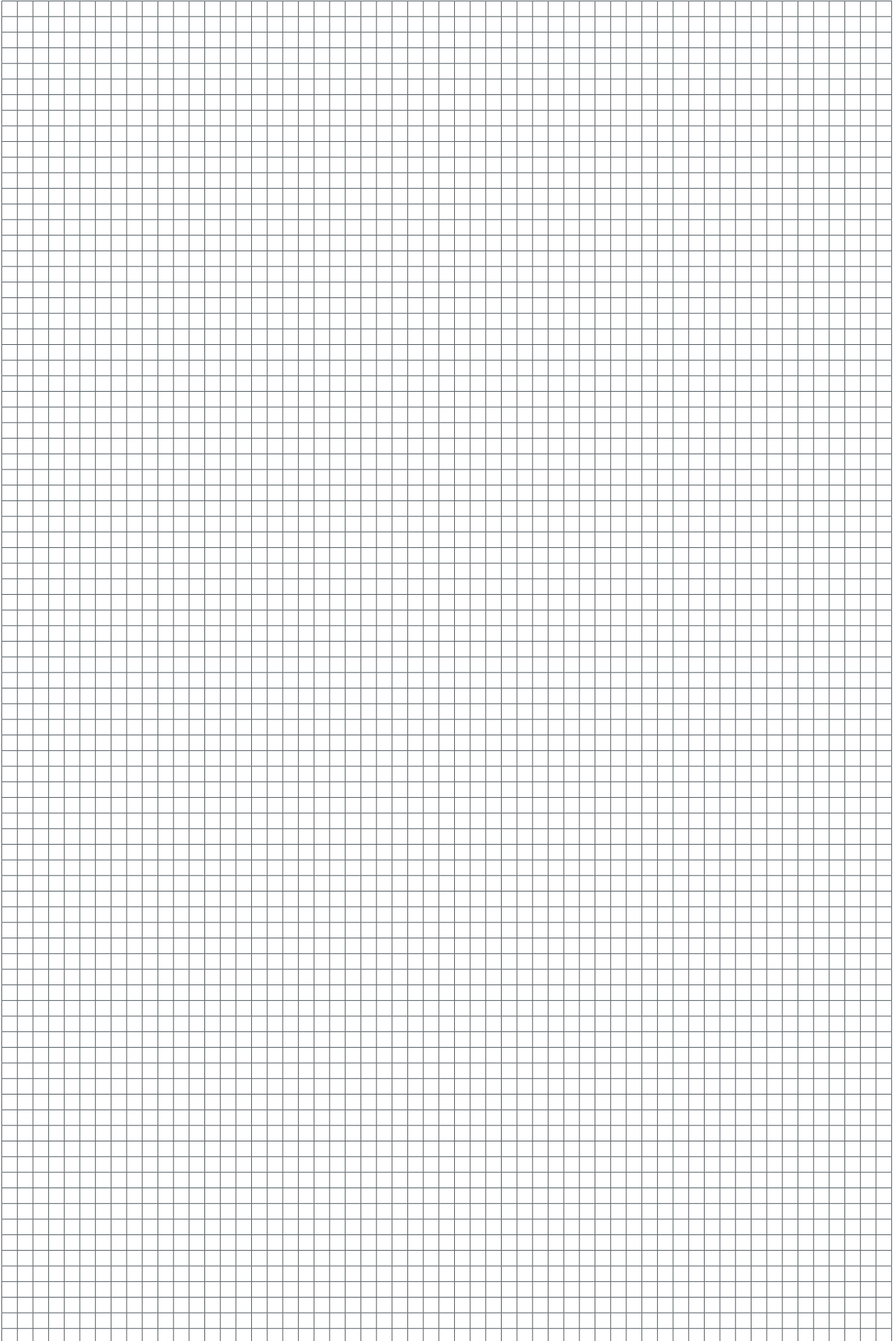



## ETA Pelletboiler

ETA PU PelletsUnit	7 - 15 kW
ETA ePE pellet boiler	7 - 56 kW
ETA PC PelletsCompact	20 - 105 kW
ETA ePE-K pellet boiler	100 - 240 kW



## ETA condensing heat technology

ETA ePE BW pellet boiler	8 - 62 kW
ETA BW condensing heat exchanger PU	7 - 15 kW
ETA BW condensing heat exchanger PC	20 - 105 kW



## ETA SH log wood boiler and TWIN pellet boiler

ETA eSH log wood boiler	16 - 40 kW
ETA eSH-TWIN combination boiler with ETA eTWIN pellet boiler	16 - 40 kW
ETA SH log wood boiler	16 - 32 kW
ETA SH log wood boiler	20 - 60 kW
ETA SH-P log wood boiler with ETA TWIN pellet boiler	20 - 60 kW
ETA SH-P log wood boiler with ETA TWIN pellet boiler	20 - 50 kW



## ETA wood chip boiler

ETA eHACK wood chip boiler	20 - 240 kW
ETA HACK VR wood chip boiler	250 - 500 kW

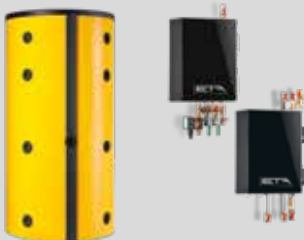

## ETA buffer tank

ETA buffer	500 l
ETA buffer tank SP	600 - 5.000 l
ETA buffer tank SPS	600 - 1.100 l

## ETA hydraulic modules

- ETA fresh water module
- ETA stratified charging module
- ETA system separation module
- ETA mixing circuit module
- ETA heat transfer module and station

Your heating specialist will be happy to advise you:



... my heating system

**ETA Heiztechnik GmbH**

Gewerbepark 1

A-4716 Hofkirchen an der Trattnach

Tel.: +43 7734 2288

Fax: +43 7734 2288-22

info@eta.co.at

www.eta.co.at

### Technical changes and mistakes reserved

In order to provide you the benefits of our continuous development, we reserve the right to change specifications without prior notice. Printing and typesetting errors or changes of any kind made in the interim are not cause for claims. Individual configurations depicted or described here are only available as options. In the event of discrepancies between individual documents regarding the scope of delivery, the information provided in our current price list shall prevail. Images and symbols may contain options that are available for an additional cost.

Photo source: ETA Heiztechnik GmbH, Lothar Prokop Photographie, istockphoto, Thinkstockphotos, Photocase, Shutterstock.  
94701-EN, Prospekt eHACK EN, 2025-01

