

ETA eSH 16-40 kW
ETA eSH 16-40 kW with eTWIN 16-32 kW

ETA^η
... my heating system



**The Log or Combination Boiler
Highly Efficient, Convenient and Flexible**



A passion for perfection.
www.eta.co.at

Heating, just the way you want to: crisis-proof, convenient and economical

The ideal solution for anyone who wants to use the inexpensive and renewable fuel wood and still enjoy the benefits of automatic heating: The ETA eSH log boiler is as convenient as it gets. In combination with a pellet boiler, it becomes the fully automatic ETA eTWIN.

Convenient and flexible

No log boiler runs fully automatically, but the eSH comes close: normally, you only have to add logs once a day - and you don't even have to light it. The boiler lights itself when heat is needed. The eTWIN does the same and is even more convenient: if no logs are available and heat is requested, the pellet boiler starts fully automatically. The free choice between logs and pellets also allows you to react flexibly to future price developments.

The many advantages of wood

Heating with wood is not only better for the climate than oil & gas, but also for the wallet - and not only at the moment, but for many years, as the graph below confirms. Moreover, it is resistant to crisis, because wood is available in abundance in Europe. Soot emissions are always criticized, but these are massively reduced in the eSH log boiler and the eTWIN: The "e" stands for efficiency and the option of installing an electrostatic precipitator, which uses electrical voltage to remove dust particles from the flue gas.



Price development of energy sources

for households 2004 - 2024

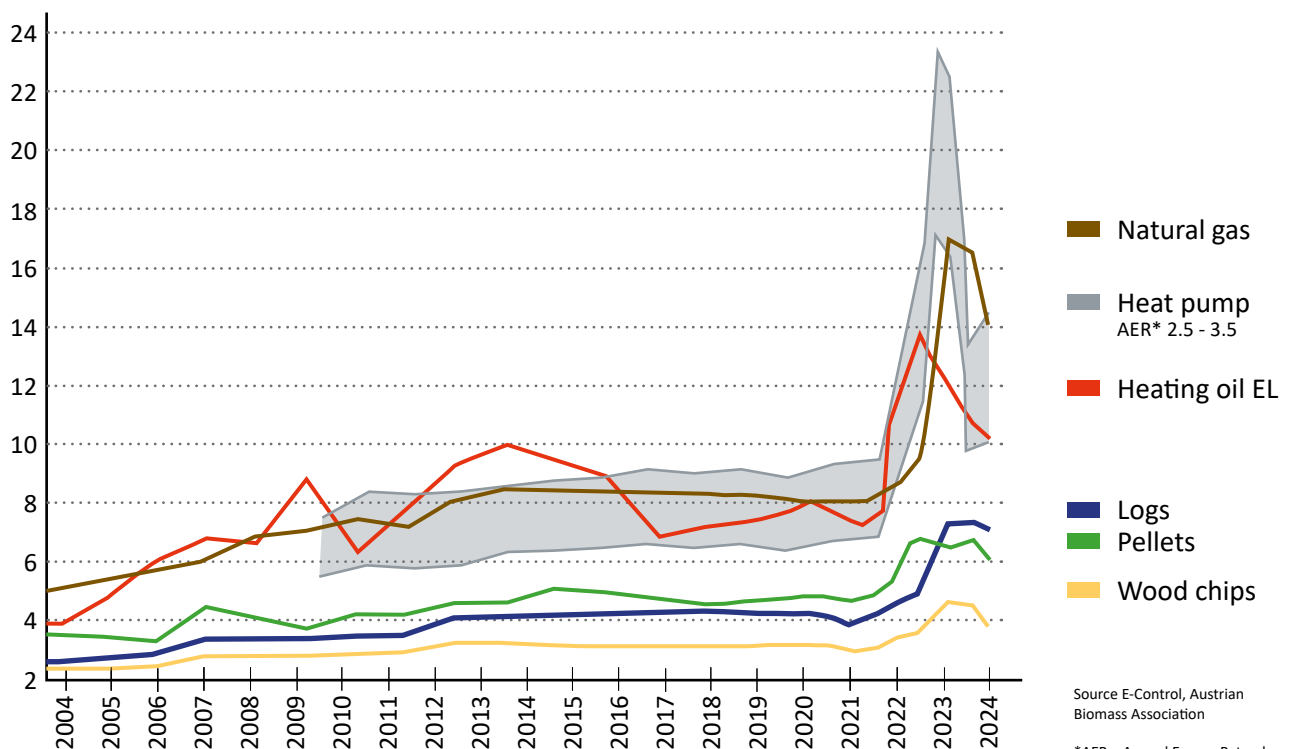

Source E-Control, Austrian Biomass Association

*AER = Annual Energy Rate: depending on the existing building

A win-win situation

Save heating costs, boost your domestic economy and help the environment in the process: heating with pellets pays off. Currently, around 7 million cubic metres of excess wood is growing in Austria - and forested areas are increasing across the whole of Europe.

Using resources sensibly

In contrast to fuels such as oil and gas, pellets hardly effect the climate. That is because trees absorb as much CO₂ during growth as they later release during combustion. In addition, the CO₂ released when burning is equal to or less than that of naturally rotting wood.

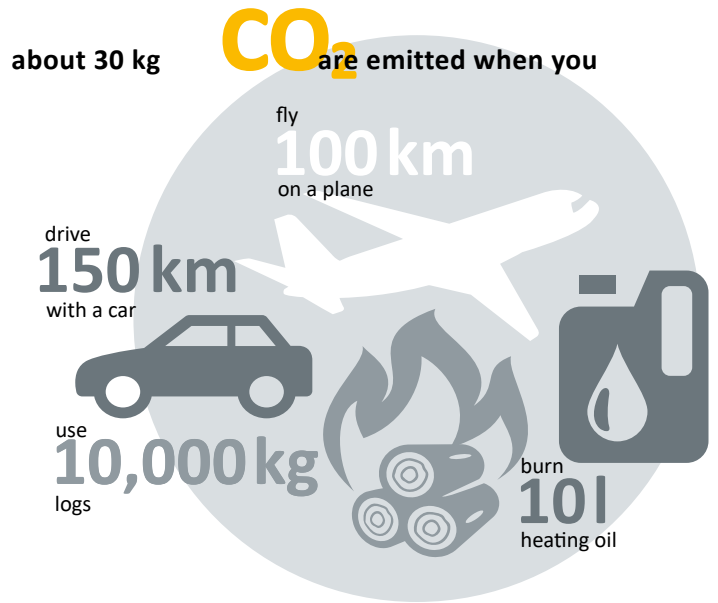

Why is heating with wood climate-neutral?

Trees absorb carbon dioxide (CO₂) from the air and release oxygen (O₂) during photosynthesis. The residual carbon (C) remains in the wood. Combustion again produces CO₂, but only as much as the tree absorbed during its growth.

In contrast, fossil fuels such as oil and gas release additional CO₂ that was stored in the ground for millions of years. This increases the amount of CO₂ in the atmosphere, which in turn contributes to climate change.

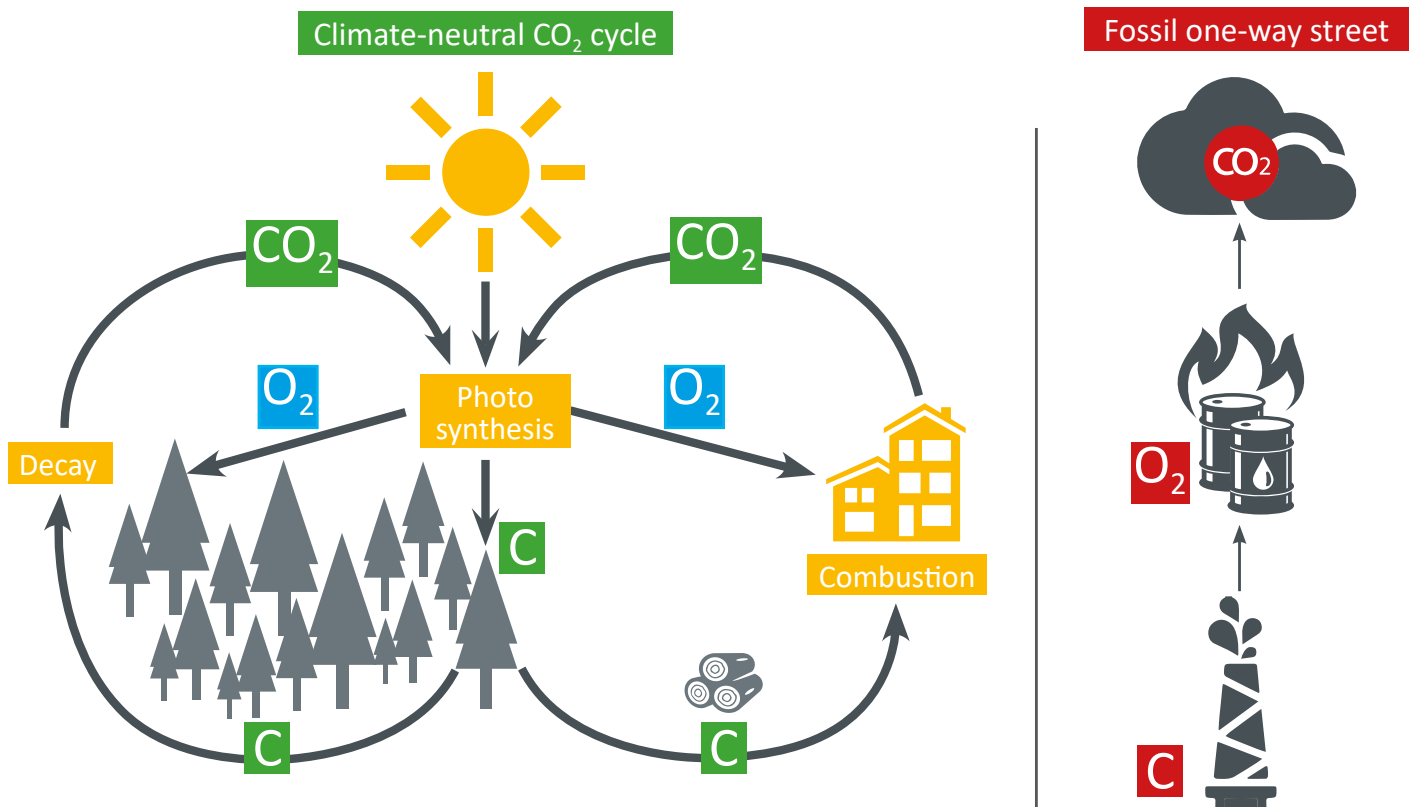

Source: Austrian Biomass Association

Wood heating with comfort

ETA eSH: Add wood and relax

The ETA eSH is much more convenient than you would expect from a log boiler. It works so efficiently that you only need to add wood once a day - maybe twice on very cold days. As soon as you have done that, you can close the door again and make yourself comfortable on the sofa: the boiler waits until the buffer storage tank needs heat and automatically ignites the logs when needed.

ETA eTWIN: It stays warm even without intervention

You appreciate the advantages of a log boiler, but you also want it to stay warm when you don't have a chance to refuel for a longer period of time? Then the ETA eTWIN is ideal, combining logs and pellets. It also lights itself - if no logs are added, it burns pellets, which are fed fully automatically.



Remote controlled via the meinETA communication platform.

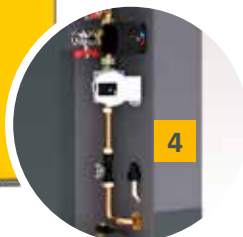

Integrated return riser

4

Ready for anything

The ETA eSH is more than a log boiler or a log and pellet boiler in the case of the eSH-TWIN. With this unit you have your entire heating and hot water supply under control – and everything is perfectly coordinated.



You can integrate the following into your boiler management:

1 Solar heating system:

with just 8 to 12 m² collector surface, all of the hot water is heated by free solar energy on sunny days. With the ETA stratified charging module, the solar heating system can be easily connected to the system.

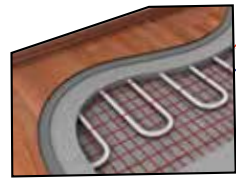

2 Buffer:

When operating a log-burning system, the installation of a buffer is indispensable. Since the fire in the boiler can only be controlled to a certain extent, on warm days - especially in the transitional period - more heat is generated than is needed for heating. The excess heat can be stored in the buffer and used when needed. So you only add split logs when you have time - completely stress-free! In the summer the boiler only has to work every few days, maybe once a week with the fresh water module, so that enough hot water is prepared for the rest of the time!

The ETA mixing circuit module for two heating circuits saves a lot of time and money during installation, as no sensor lines, pumps or mixer cables have to be installed.

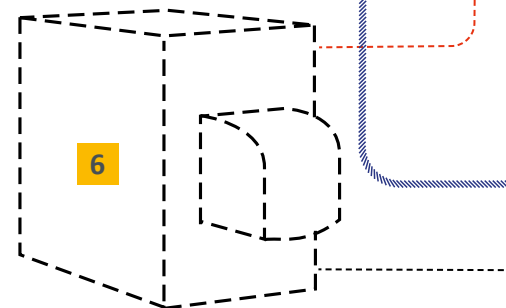

3 Buffer management: Together with the start relief, this ensures that your house is heated especially quickly. Possibly available residual heat from the buffer additionally accelerates the start-up.

4 Integrated return riser: Protects the boiler against corrosion and saves energy, so that the residual heat can also still be optimally used at the end of the firing phase.

5 Fresh water module: It doesn't need much space, because it can be built into the buffer storage tank or hung on the wall and always prepares hot water for showering, drinking or dishwashing fresh and hygienically. Of course, a conventional hot water tank can also be integrated into the boiler system.

6 Additional heat generators: Oil, gas or further pellet boilers can also be integrated in the ETA system. These are simply started from the wood boiler.

7 Excess from PV system: The ETA buffer storage tanks can be equipped with a heating element, whereby the control of the PV system uses the excess electricity for heat.

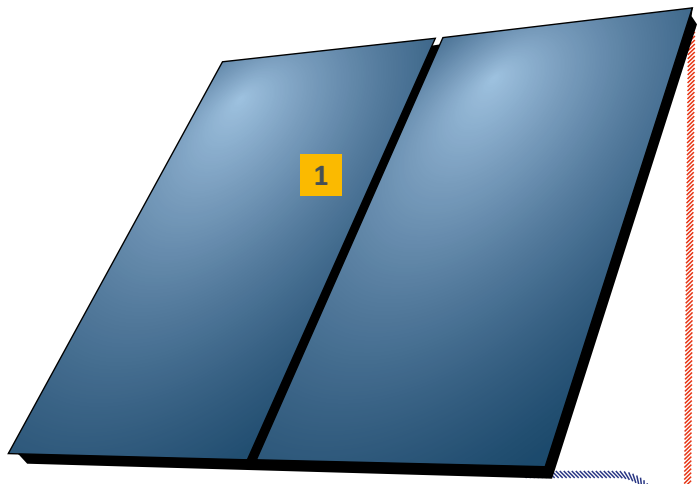

Which buffer storage tank size?

Minimum buffer volume = Filling chamber volume (boiler) x 10
 Recommended buffer volume = Filling chamber volume (boiler) x 15

In order to achieve the best use of heat, a larger buffer tank is recommended, as heating needs to be done less often.

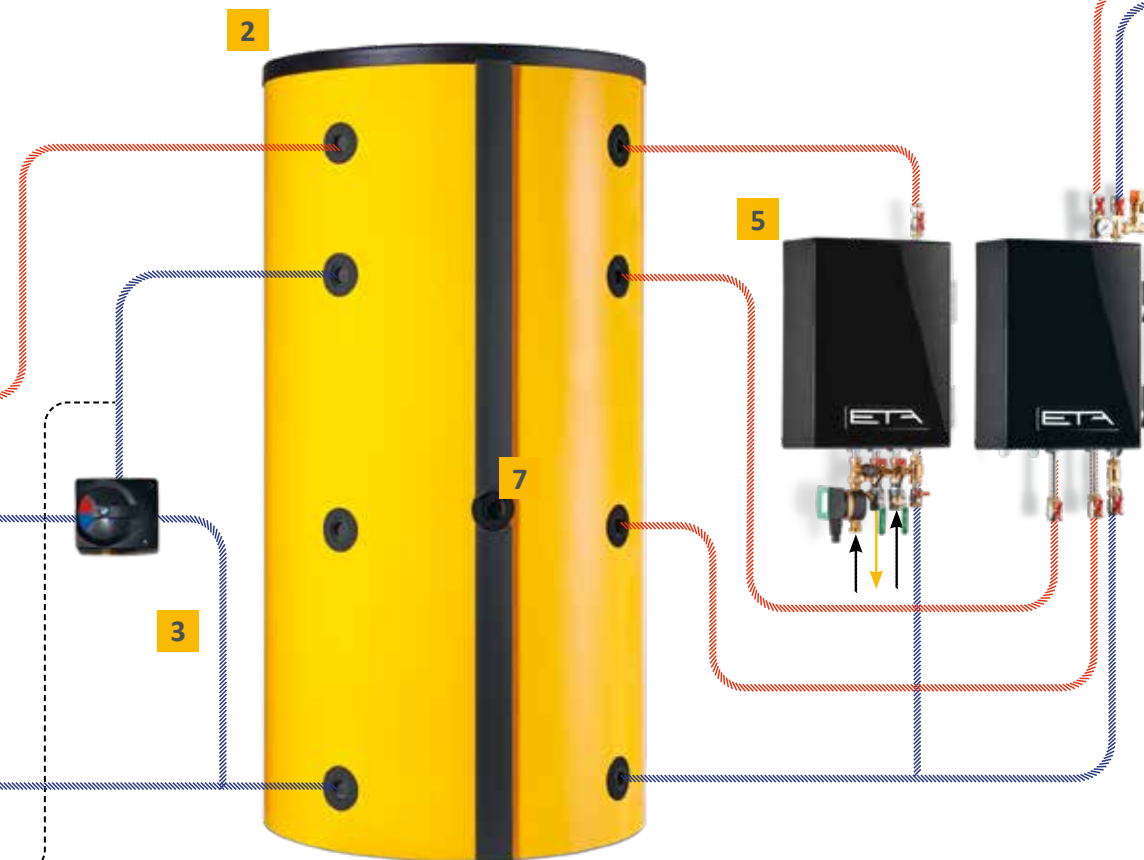

Everything at a glance!
 The ETA room sensor displays the room as well as the outside temperature and enables easy changing of the desired room temperature.

The way to heat

In the ETA log boiler, many components work together perfectly to achieve an optimum result and make heating as convenient as possible.

- 1 Insulation door:** Because you want to heat the living space and not the boiler room, the insulated outer door protects against heat losses - and does so very well. The door hinge can be mounted on the left or right - depending on the direction from which the logs are to be loaded.
- 2 Large fuel chamber doors:** So that adding wood is really simple!
- 3 Carbonization gas extraction:** It is active when you add fuel and ensures that no gas can escape when the fuel chamber doors are open.
- 4 Filling chamber for half-meter logs:** Volume of 100 liters (eSH16-20) and 180 liters (eSH26-40)
- 5 Automatic ignition:** The logs are ignited as required.
- 6 Heat-resistant combustion chamber:** Ensures optimal burnout and a long service life
- 7 Pellet flange:** For easy integration with the ETA eTWIN pellet burner.
- 8 EC draught fan:** Quiet as a whisper and very economical thanks to EC motor technology.
- 9 Automatic heat exchanger cleaning:** The heat exchanger is cleaned fully automatically with turbulators. This ensures consistently high efficiency and increased convenience.



The way through the boiler:

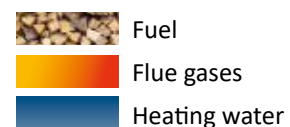



- 10 Primary and secondary air flap:** Both flaps are controlled via the lambda probe, so that the ideal amount of air always reaches the combustion chamber for combustion.
- 11 Lambda probe:** Thanks to automatic signal calibration, it gets the best possible heating value from any wood.
- 12 De-ashing, cleaning and maintenance from the front:** This is not only convenient but also makes setting up the boiler in small boiler rooms easy. There are no side doors for which additional space is needed.
- 13 Touchscreen:** The capacitive touchscreen can be adjusted by tilting or swivelling for individual operator convenience.
- 14 Hydraulics built into boiler:** Return riser with mixer and flow sensor for heat quantity measurement are already integrated in the boiler.
- 15 Integrable precipitator:** It ensures optimum flue gas cleaning throughout without any cleaning effort.



High-performance combustion chamber

The modern combustion chamber is the result of years of experience in boiler construction as well as detailed combustion simulation: Equipped with expansion joints, it compensates for temperature differences and thus hardly wears out due to the robust materials. Flue gases are minimised through optimised flue gas flow, resulting in increased efficiency.

Safely with negative pressure

EC draught fan. Quiet as a whisper, this speed-controlled fan ensures constant negative pressure in the boiler. It works very economically thanks to EC motor technology. Additionally, the draught fan ensures oxygen supply in the combustion chamber and therefore for ideal burning behaviour and best utilisation of the fuel. Through the sophisticated boiler construction, the draught fan produces sufficient negative pressure in the boiler, so that, contrary to conventional systems, no additional pressure fan is needed. The underpressure sensor provides for even more efficient control of the draught fan. It measures the negative pressure in the boiler and optimises the air supply in the combustion chamber. This minimises operating costs!



Lambda probe

Makes the right mix. Whether you heat with beech or spruce, supply large or small pieces of wood, or whether the boiler is starting up or is in full operation – the ideal combustion always comes when the amount of supplied air is just right. The correctly placed lambda probe is the brains of the combustion technology, so to speak. It regulates how much oxygen is currently being used. The result: high efficiency and low emissions.

Automatic ignition

It couldn't be simpler or more convenient: you determine the time at which you insert the wood and the standard automatic ignition takes care of the rest. Controlled, silent and demand-based, the ignition is only activated when the house needs heat and the buffer storage tank is empty.





Hydraulics - All-in-one

The main elements for heat distribution are already integrated in the boiler. These include a pump, a mixer for the return riser and shut-off devices.

A flow sensor is installed as standard to record the amount of heat generated!

Precipitator

Clever use of a natural phenomenon

Why does dust keep building up on the computer screen? It is because the dust particles are electrostatically charged and are attracted by the screen. – ETA makes use of this effect in its precipitator. With the aid of an electrode in the flue gas duct the particles which are swirling in the flue gas are energised and ionised. They are deposited on the internal wall of the separator and can no longer escape from the chimney with the flue gases.



Heat exchanger

Best efficiency, easy cleaning. Targeted air supply in the heat exchanger pipe ensure the highest efficiency and an even heat exchange.

The heat exchanger is cleaned fully automatically with turbulators. This ensures consistently high efficiency and increased comfort.

Pellet burner connection

Convert your eSH log boiler into a combination boiler at any time: The flange for connecting the eTWIN pellet burner is installed as standard. So it's up to you if you want to heat fully automatically. To do this, you don't have to replace the entire system, but can simply retrofit the pellet burner.



The way to heat

Two combustion chambers, one heat exchanger, one boiler: The ETA eSH-TWIN links a top-class pellet burner with a premium log boiler. In order for both parts to work highly efficiently, all components must work together perfectly.

Through the pellet burner:

- 1 Powerful vacuum turbine:** It transports the pellets from the store room to the intermediate container of the boiler.
- 2 Pellet bin:** Here, 40 kg of pellets are stored temporarily and are immediately available for burning. So pellets have to be transported from the store room to the boiler only once or twice a day for 10 minutes. You decide when that should be.
- 3 Rotary valve as burn-back protection device:** It is the completely sealed closing door between pellet store and combustion chamber and, therefore, safely protects against burn-back.
- 4 Water fed pellet combustion chamber:** As pellets have different combustion properties than logs, the highest efficiency can only be reached with separate combustion chambers.
- 5 Revolving grate with cleaning comb:** This patented system cleans the combustion chamber regularly of ash and slag.

Pellet burner and log boiler:

- 6 Connection flange:** This is where the combustion chambers for pellets and logs are connected.
- 7 EC draught fan:** Quiet as a whisper and very economical thanks to EC motor technology.

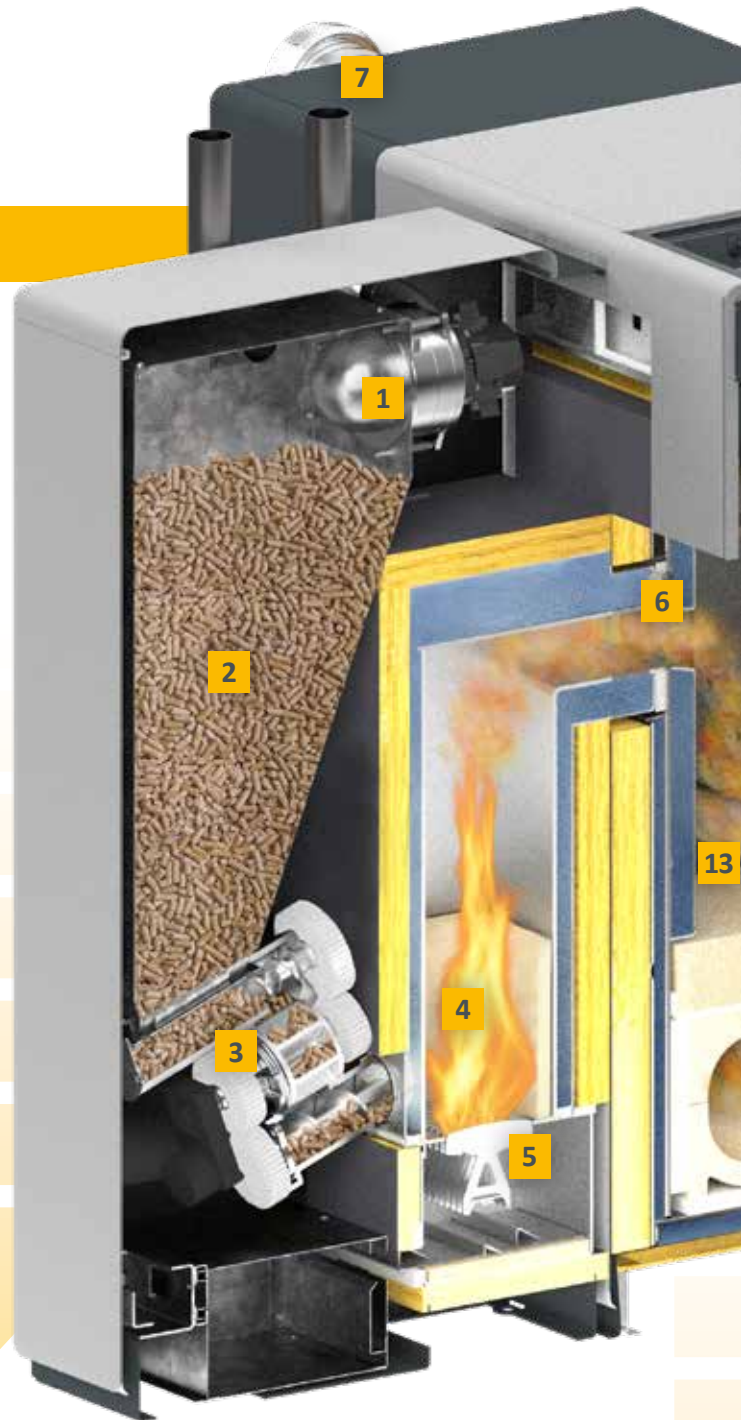





Through the log boiler:

- 9 Insulation door:** Because you want to heat the living space and not the boiler room, the insulated outer door protects against heat losses - and does so very well.
- 10 Large fuel chamber doors:** So that adding wood is really simple!
- 11 Carbonization gas extraction:** It is active when you add fuel and ensures that gas never escapes when the fuel chamber doors are open.
- 12 Filling chamber for half-meter logs:** Volume of 100 liters (eSH16-20) and 180 liters (eSH26-40)
- 13 Heat-resistant combustion chamber:** Ensures optimal burnout and long service life
- 14 Touchscreen:** The capacitive touchscreen can be adjusted by tilting or swivelling for individual operator convenience.

- 8 De-ashing, cleaning and maintenance from the front:** This is not only convenient but also makes setting up the boiler in small boiler rooms easy. There are no side doors for which additional space is needed.

The way through the boiler:

-  Fuel
-  Flue gases
-  Heating water

Perfect combination

It doesn't matter whether you mainly burn logs or pellets: In the eSH-TWIN, both systems are perfectly combined. The switchover works automatically - so it never gets cold.

Logs are usually the cheaper option for heating with wood, but you have to put them in yourself. But that's all: you press the automatic button and the boiler starts as soon as heat is needed. A lambda probe detects the condition of the combustion material, the air supply is automatically adapted to the wood quality. The ETA log boiler therefore also gets the highest possible efficiency from mixed wood or wood briquettes.

Automatically always warm. When the logs run out in the boiler and it cannot produce any more heat, the system accesses the buffer storage tank as required. If the energy stored there is also consumed, it still doesn't get cold thanks to the eTWIN. Even if you don't add fuel. The pellet automation of the ETA eTWIN simply takes over. You don't have to do anything, not even set a control system.

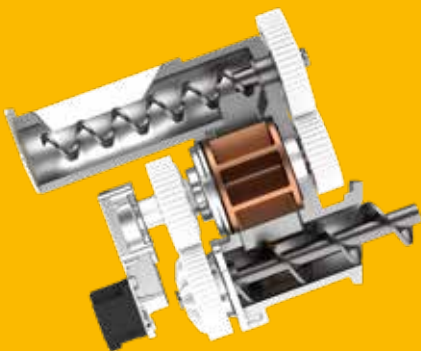

Rotary valve

The safe system. The rotary valve absolutely protects you from burn-back: burning should only take place in the combustion chamber and nowhere else.

A dosing screw transports the pellets to the rotary valve – and only as many as the rotary valve can handle. This is why the pellets do not become wedged, crushed or broken. Thanks to this system developed by ETA, the sealed edges of the rotary valve do not wear out. The system remains safe throughout the entire service life of the boiler.



Noiseless ceramic lighter ignition

Sparking technology. The energy expended for the ignition is much less in comparison with other ignition systems. The ignition itself works quicker.

Rotating grate with cleaning comb

Clean burns well. This system regularly cleans the combustion chamber of ash and slag. This process is started automatically after a certain amount of burned pellets. The air required for the combustion process is distributed extensively between the clean grate segments. Additionally, the grate is constantly kept in slight motion. The gentle movement stokes the firebed and thus ensures even better combustion.

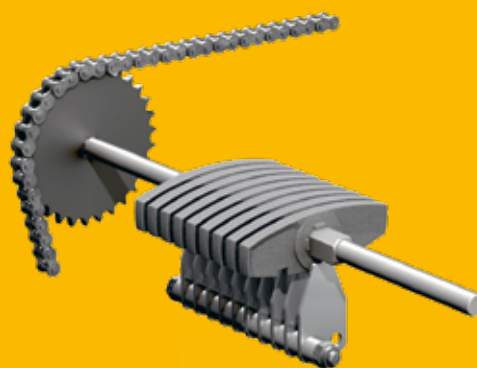

The ash is compacted and ends up in the ash box. Even at full load operation, the boiler only has to be emptied from time to time. When it is time, the system sends an email. The information is also displayed on the touch display.



Pellet hopper for pellets

Well provided for: 40 kg of pellets are stored here temporarily and are immediately available for burning. So pellets have to be transported from the store room to the boiler only once or twice a day for 10 minutes. You control when that should be.

Always space for pellets

The pellet store can easily be set up anywhere an oil tank has stood before. It doesn't even have to be near the boiler, but can be situated up to 20 m and two storeys away. If there's no space in the house, the storage room can also be set-up in an adjacent building, or an underground tank can be used. The store room just needs to be dry so that the pellets don't swell up. Wooden cladding can help in rather damp rooms.

A clean solution

The small rolls, which are pressed from the waste products of the wood industry, are delivered by tanker and blown into the storage room. So the delivery of pellets is an extremely clean process. If the storage is sealed, then no dust can escape here either.

How big does my storage room have to be?

The approximate pellet requirement per year in tonnes is calculated by dividing the heating load in kilowatts by 3. To calculate the pellet requirement in cubic meters, divide the heating load by 2.

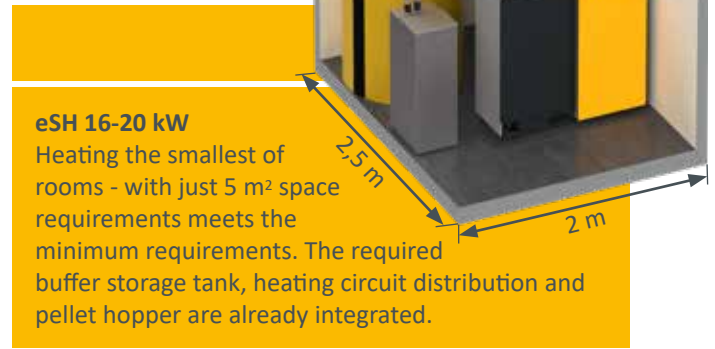

For example for a 12 kW heating load, you need 6 m³, or approx 4 tonnes of pellets, per year. When moving from another energy source to pellets, the pellet requirement can also be determined from the previous consumption.

1 tonne of pellets roughly corresponds to:

- 500 l heating oil
- 520 m³ natural gas
- 750 l LPG
- 600 kg coke
- 1,400 kWh electricity with geothermal heat pumps (practical coefficient of performance 3.4)
- 2,000 kWh electricity with air heat pumps (practical coefficient of performance 2.5)

How do the pellets get to the boiler?

Discharge screw:

It stretches the entire length of the store room, can be up to 10 m long and transports the pellets from the store room to the transport hoses, which lead to the boiler. From here, the pellets are conveyed further with a vacuum turbine. After transport the hoses are vacuumed empty. Hence they do not clog up and always work with the highest degree of efficiency. With this standard system, the storage room can be completely emptied.

The pellets automatically slide to the transport screw over the inclined smooth floor. The impact protection mat is suspended opposite the filling nozzles, so that the pellets do not shatter on the wall when they are blown into the storage room from the truck. The requirement for this construction is that the connections for the transport hoses to the boiler are located on the narrow side of the store room, so that the whole length of the room can be used with the screw.

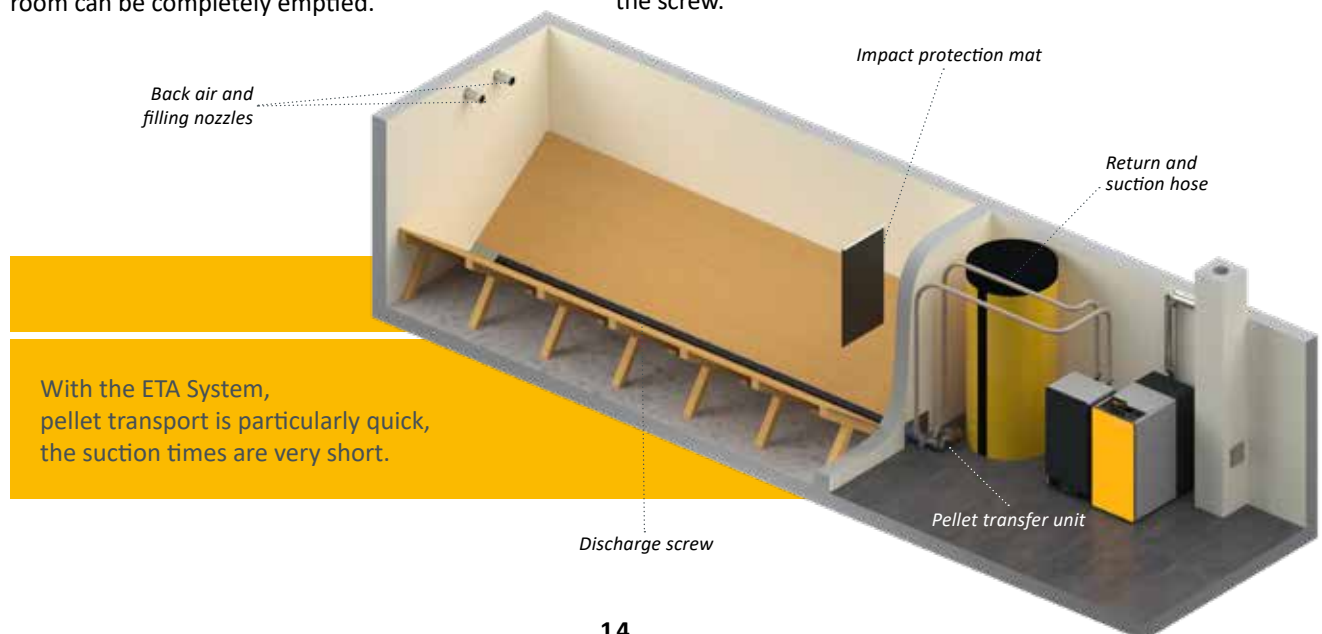

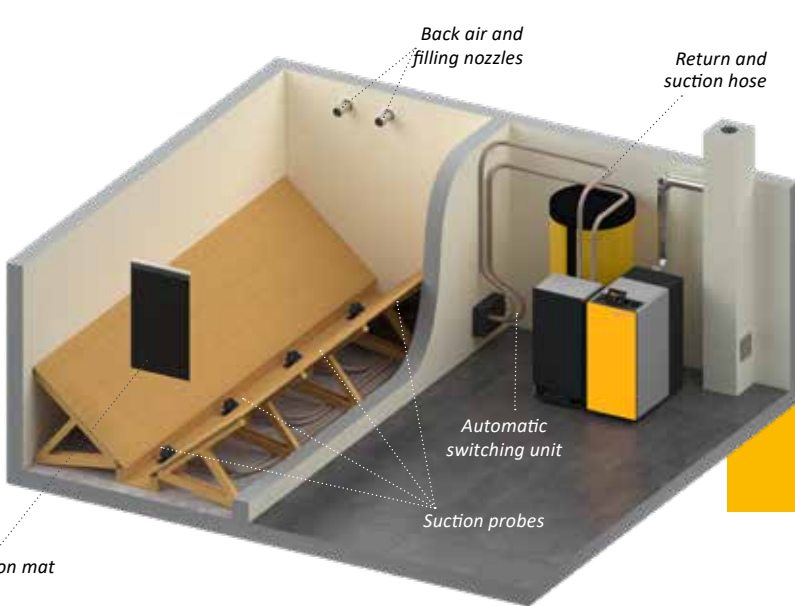

With the suction probes, nearly all rooms can be used as a pellet store, even if the room is angular.

Suction probes:

If the shape of the room is not suitable for a discharge screw, the ETA suction probe system is the ideal choice. Here, the pellets slide over the slanting and smooth wooden floor directly to the four suction probes, which alternately transport pellets away from the store room. Through automatic switching, the fuel supply is not interrupted if a probe does not get any pellets at a certain point in time. A prerequisite for this system is that the store room is situated opposite the boiler in the same storey or higher, and that the store room is no longer than 4 m. Unlike the discharge screw, suction probes do not fully empty the store room. When the store room capacity is tight, this can be a disadvantage. The advantage is that this system can be used even in angular store rooms.

How big does the store room have to be?

Heating (calorific) value of the pellets = 4.9 kWh/kg
 Weight of the pellets = 650 kg/m³

Rules of thumb for pellet requirements

9 kW heating load / 3 = 3 tons of pellets per year
 9 kW heating load / 2 = 4.5 cubic metres per year

Are you short of space in the boiler room? Do you mainly use logs? Is your annual consumption of pellets low? Then perhaps you don't need a pellet store room, but only the manually fillable hopper from ETA. It's directly connected to the boiler with hoses. You can fill it with bagged pellets and heat for about a week without refilling. Its storage capacity then is significantly larger than that of the small intermediate container directly on the boiler.



ETA tip: Storage in ETAbox

The ETAbox is a particularly practical solution. It can be set up directly in the boiler room, in the attic, in a barn or – if covered – even outside. It even keeps the pellets dry in damp rooms. Distances of up to 20 meters of suction stretches from the box to the boiler are no problem. The ETAbox cannot be set up directly on the wall, however. Which is why the space required is a bit larger compared to a brick store with the same capacity.

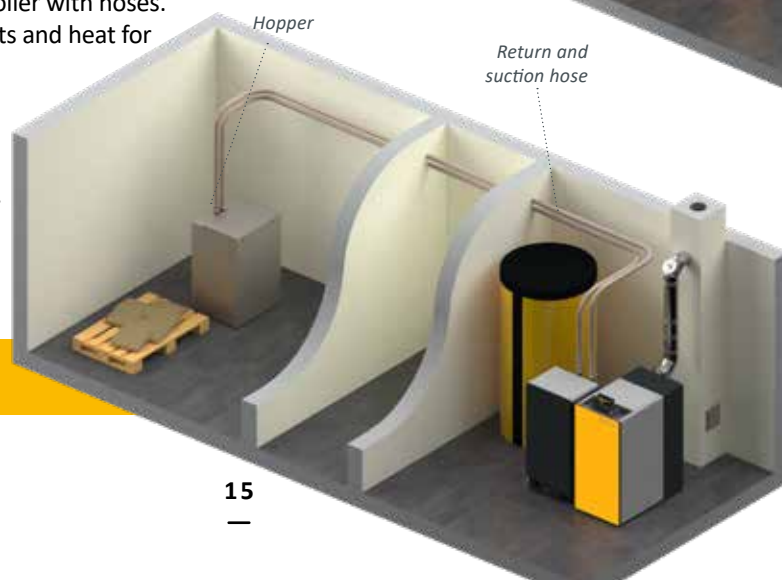

Simple and can be controlled from anywhere

Good technology is characterized by being user-friendly. You don't have to be a technician to use ETAtouch's many functions.

ETAtouch: the touchscreen as heating control

The days of confusingly arranged buttons and controls are over, because with the touchscreen of the ETA control system you can make all settings conveniently and easily. The icons are self-explanatory. Whether you generally have warmer or cooler temperatures, want to change the time for night setback or want to switch to setback mode during your vacation - you will intuitively tap on the right illustration without any operating instructions!

You can control your heating system via touchscreen and also have an overview of all integrated components such as buffer tanks, solar systems or hot water tanks.



Heating, night setback, Holiday setting: the operation is immediately clear



the free of charge internet platform

If your ETA control is connected to the internet, you can view and change all heating settings on your smart phone, tablet or PC. So you have your heating under control, no matter where you are!

When you log in at www.meinETA.at, you will see the touchscreen exactly as if you were standing directly in front of the boiler. If necessary, mein-ETA will also inform you free of charge by email about your heating system.

Within your own house network, direct access to the ETAtouch control of your heating system can also be achieved via VNC.

Quick help

Give your installer temporary access rights to your meinETA account. This way he can prepare for his visit to you. And maybe the technician doesn't even have to come because, thanks to myETA, he can tell you over the phone what you need to do to ensure that your heating system is optimally adjusted. You can see who can access your control via the status display. You always decide who belongs to your partner network!



For tablets, smartphones and PCs

meinETA runs on all common operating systems such as iOS or Android. meinETA can be loaded via PC using any modern internet browser.



Everything is very simple



Perfect for your smart home

The ETAtouch control can be easily integrated into common smart home systems as well as into a building management system (BMS). The mini server of the Loxone system exchanges data directly with the boiler via a ModbusTCP interface. And all you need to connect to a KNX bus system is the optionally available ETA KNX interface and a few simple clicks.

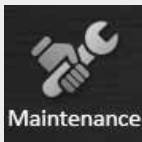

Maintenance assistant

Simply maintain your boiler yourself: the instructions on the boiler's touch display guide you step by step through the annual cleaning.

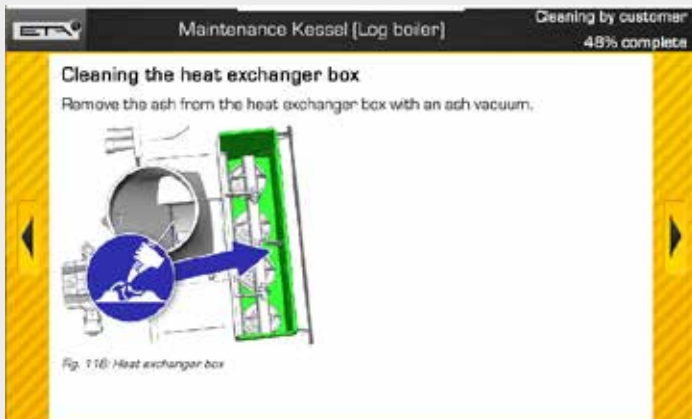

ETA individual room control interface example:

Whether Loxone, KNX or ETA individual room sensor with or without display: everything can be controlled via ETAtouch. It always passes on the correct signals to the valve controllers, which control how much hot water should come through to the respective room or heating section.

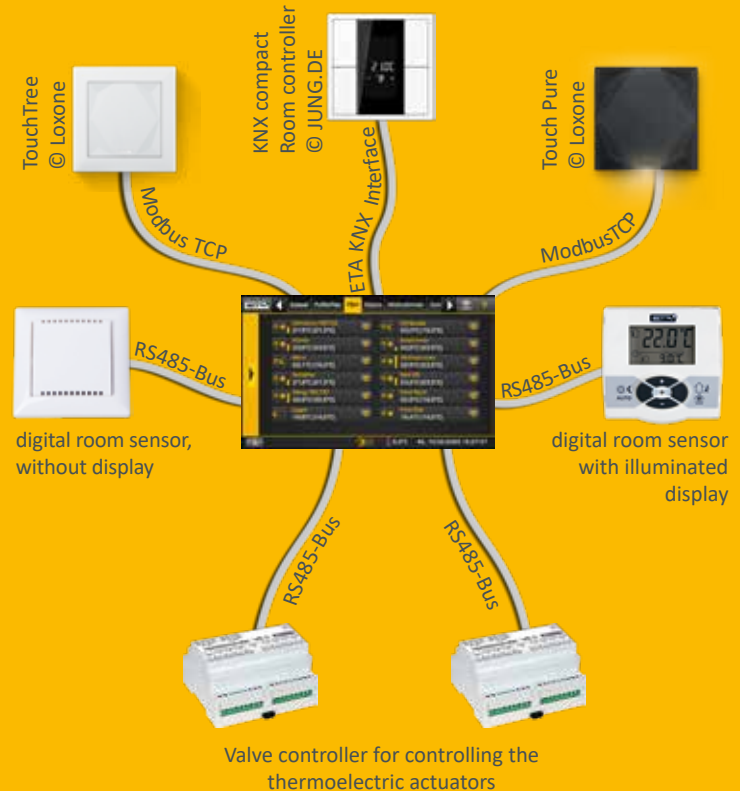

Everything on one display: the ETA Standard

A modern heating system is only effective if it is well-controlled. ETAtouch takes care of that.

At no added cost, the ETAtouch control system already includes all functions for two heating circuits, hot water supply via tank or instantaneous hot water module, as well as for the integration of a solar heating system. All ETA heating boilers also come with a LAN connection as standard. If you connect the boiler to the internet, you can easily control all components from a PC, tablet or smartphone.

Boiler and combustion regulation*

Speed-controlling the several components save power. The lambda and ignition time regulation increases efficiency. All components relevant to operation are monitored.

Buffer storage tank management**

Three to nine sensors in the tank control the heat generator in the system and distribute the energy to the different consumers. From using five sensors, cascading regulation, QM-Holz and peak load management are part of the ETA Standard.

Domestic hot water preparation*

Is made possible both via the ETA instantaneous hot water module but also via the hot water tank or combination tank. For all variants, circulation pumps can be controlled with time and/or requirement programs.

Solar heating systems**

Single or double circuit solar heating systems with one or two tanks, zone loading via the ETA stratified charging module and also two collector fields as well as three consumers are controlled.

Two weather-controlled mixing heating circuits**

They run with a weekly program which allows many time windows and automatic and/or manual additional functions. The system can optionally be expanded with room sensors and remote control.



Comprehensible also without the need for an operating manual: The symbols on the touchscreen are self-explanatory. So controlling the heating system becomes child's play.

Additional system functions

Detection of third-party heating devices, such as oil boilers, gas boilers, heat pumps and wood burning stoves, thermostat or differential temperature thermostat, external demand from external devices such as heating fans, control of transmission lines, with or without mixers, and also of heat transfer stations, single room control systems, for example.

Wall-mounted control box for more complex systems

All control systems can be extended with wall-mounted control boxes, with or without touchscreen.

* Control system and sensor included in standard delivery scope

** Control system depends on configuration, sensors are available as accessory

From Hausruckviertel to the world

ETA specialises in the manufacture of biomass heating, i.e. log, pellet and wood chip boilers. The most modern technologies combined with naturally growing resources.

ETA is efficient

Technicians designate the efficiency of a heating system with the Greek letter η , pronounced „eta“. ETA boilers stand for more heat with less fuel consumption, environmental soundness and sustainability.

Wood: old but excellent

Wood is our oldest fuel - and our most modern: There is a lot of history - from open fires in front of caves to modern biomass boilers. In the middle of the 20th century, the number of wood heating systems briefly fell. Oil heating became the new, hyped option. A brief interlude in comparison to the consistency of wood. Today, we know that heating with fossil fuel has no future. It contributes to global warming and harms the environment. Supply security is also not guaranteed in the long term, as fossil fuels are being depleted, aren't renewable and often come from unstable regions. While wood by contrast is a cheaper, locally grown, renewable raw material that does not pollute the climate when burnt. No wonder wood heating is booming!

Comfort with many components

Since December 1998, the Upper Austrian company ETA has been designing and building a new generation of wood-fired boilers. They are full of patented technologies and the most modern control technology – making them easy to use. Convenience and efficiency make ETA products so popular around the world. With a production capacity of up to 35,000 boilers per year and a global export proportion of around 80%, ETA is one of the leading biomass boiler producers.

You get more than just a boiler

Anyone who decides on a wood or pellet boiler from ETA is choosing sustainability. This is not just in terms of fuel, but encompasses responsibility across the board, with sustainable workplaces in the region. More than 400 employees in Hofkirchen an der Trattnach have the best working conditions – including an in-house restaurant, bright assembly and storage halls, a fitness room and a sauna. There is even a free electric charging station for electric cars, which is supplied by the in-house photovoltaic system. This also covers all the power needed of a production hall and thus saves around 230 tonnes of CO₂ per year.



Log boiler ETA eSH 16-20 kW

1 Flow, 1" ball valve

2 Return, 1" ball valve

3 Connection for safety valve, pressure gauge and bleed valve R3/4" internal thread

4 Safety heat exchanger R1/2" external threads

5 Filling and draining valve

Optimum maintenance area. Fixed components (e.g. expansion tank, hot water tank) in this area may require more cleaning and maintenance. The dimensions marked with an asterisk symbol (*) indicate the minimum dimensions for the maintenance area.

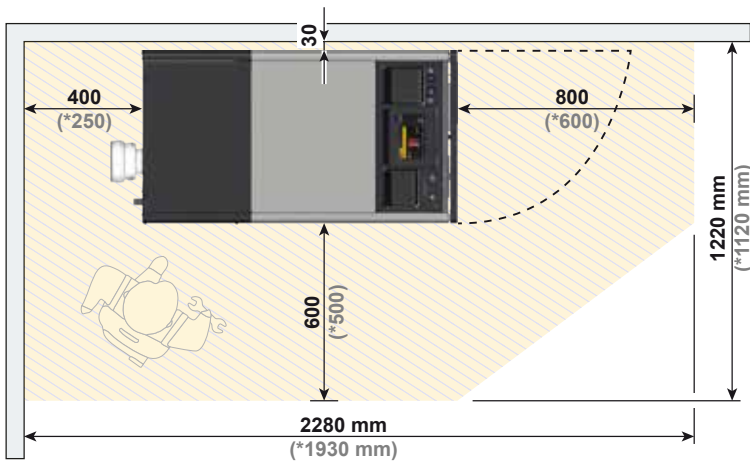
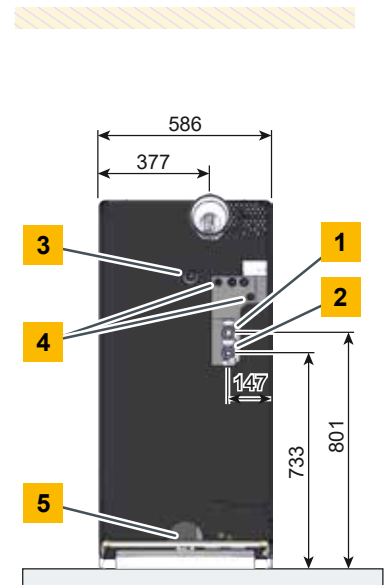
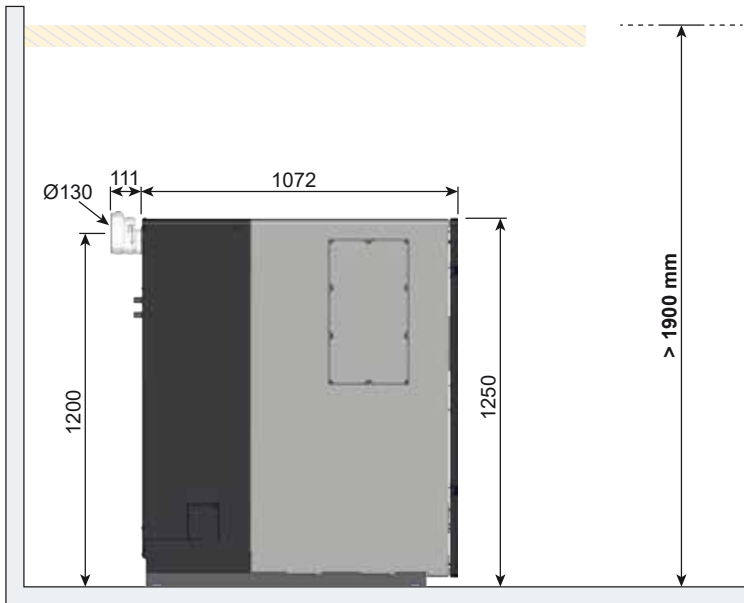

The optional eTWIN pellet burner can only be mounted on the left side of the boiler. If the eTWIN pellet burner is to be retrofitted, the additional space required for the pellet burner is to be taken into account when setting up the log boiler.





Log boiler eSH	Unit	16	20
Rated capacity	kW	16	20
Efficiency at partial load (=values with integrated precipitator)	%	94.3 (94.7)	94.2 (94.1)
Energy efficiency class "package-system"		A++	A++
Fuel chamber	mm	560 mm deep for 0.5 m logs 422 x 322 mm door opening	
Fuel chamber volume	litres	102	
Transport dimensions W x D x H	mm	586 x 1102 x 1250	
Weight	kg	460	460
Water content	litres	69	
Required flue draught A draught limiter is recommended above 25 Pa.	Pa	> 5	
Electrical power consumption at full load (=values with integrated precipitator)	W	31 (67)	33 (58)
Recommended buffer volume	litres	> 1100, optimal 1650	
Required buffer volume in Germany (1st BimschV / German Federal Immission Protection Ordinance)	litres	880	1100
Maximum permissible operating pressure	bar	3	
Temperature adjustment range	°C	70 - 85	
Maximum permissible operating temperature	°C	85	
Boiler class		5 according to EN 303-5	
Suitable fuels		Logs EN ISO 17225-5, with maximum 20% water content	
Electrical connection		1 x 230 V / 50 Hz / 13 A	
Mode of operation		non-condensing	

Subject to technical changes and errors

Complies with
EU standards



Austrian Ecolabel



ETA eSH-TWIN combination boiler

- 1** Flow, 1" ball valve
- 2** Return, 1" ball valve
- 3** Connection for safety valve, pressure gauge and bleed valve R3/4" internal thread
- 4** Safety heat exchanger R1/2" external threads
- 5** Filling and draining valve
- 6** Pellet suction hose DN50
- 7** Pellet return air DN50

Optimum maintenance area. Fixed components (e.g. expansion tank, hot water tank) in this area may require more cleaning and maintenance. The dimensions marked with an asterisk symbol (*) indicate the minimum dimensions for the maintenance area.

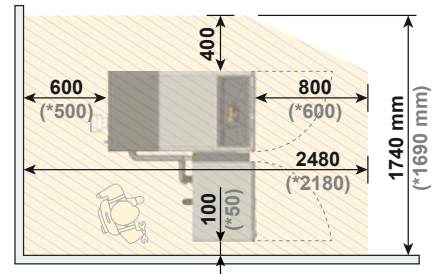
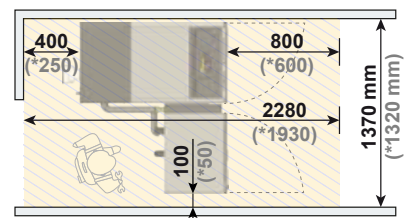
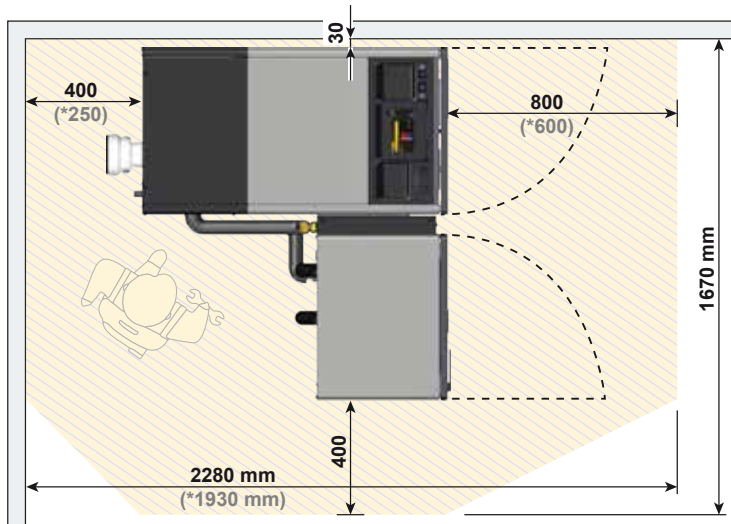
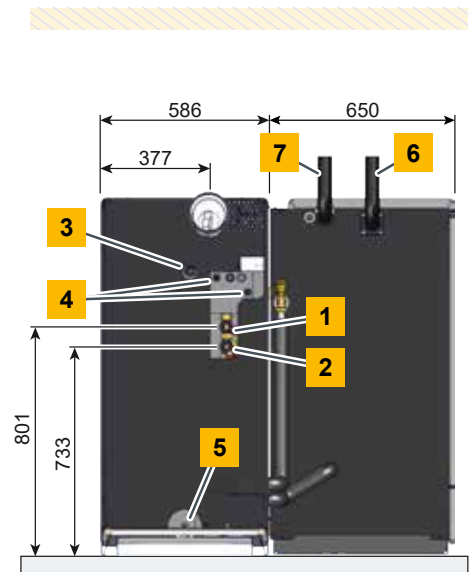
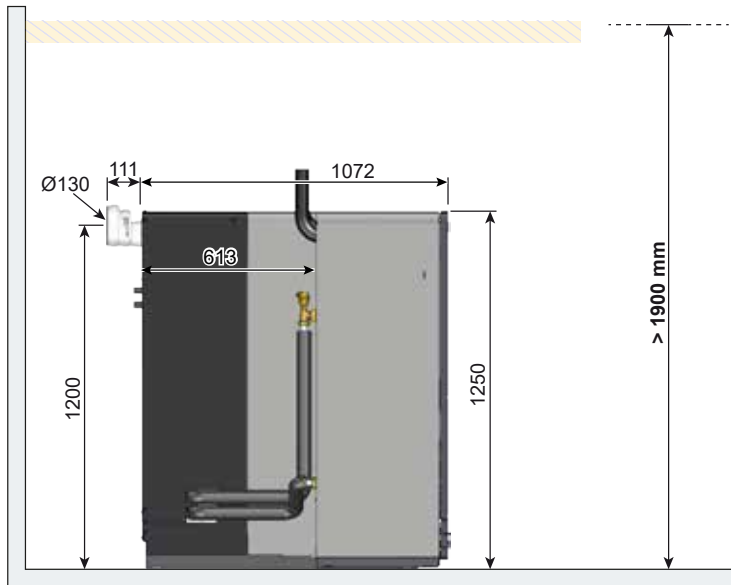



Combination boiler eSH-TWIN	Einheit	16
Rated heat capacity pellet burner eTWIN	kW	4.8 - 16
Rated heat capacity log boiler eSH	kW	16
Efficiency pellet burner at partial/full load	%	92.6 / 94.5
Efficiency log boiler at partial/full load	%	94.3
Energy efficiency class "package-system"		A++
Fuel chamber log boiler eSH	mm	560 mm deep for 0.5 m logs 422 x 322 mm door opening
Fuel chamber volume log boiler eSH	litres	102
Transport dimensions W x D x H pellet burner eTWIN	mm	740 x 546 x 1494
Transport dimensions W x D x H log boiler eSH	mm	586 x 1102 x 1250
Weight pellet burner eTWIN	kg	146
Weight log boiler eSH	kg	460
Water content pellet burner eTWIN	litres	13.9
Water content log boiler eSH	litres	69
Pellet bin on boiler (net)	kg	33 kg (162 kWh)
Maximum distance to pellet store	m	20
Ash box volume	litres	15
Required flue draught A draught limiter is recommended above 25 Pa.	Pa	> 5
Recommended buffer volume	litres	> 1100, optimal 1650
Maximum permissible operating pressure	bar	3
Temperature adjustment range	°C	70 - 85
Maximum permissible operating temperature	°C	85
Boiler class	5 according to EN 303-5	
Suitable fuels	Logs EN ISO 17225-5, with maximum 20% water content and Pellets EN ISO 17225-2-A1, ENplus-A1	
Electrical connection	1 x 230 V / 50 Hz / 13 A	
Mode of operation	non-condensing	

Subject to technical changes and errors

Complies with
EU standards



Austrian Ecolabel



Log boiler ETA eSH 16-20 kW

- 1** Flow, 1" ball valve
- 2** Return, 1" ball valve
- 3** Connection for safety valve, pressure gauge and bleed valve R3/4" internal thread
- 4** Safety heat exchanger R1/2" external threads
- 5** Filling and draining valve

Optimum maintenance area. Fixed components (e.g. expansion tank, hot water tank) in this area may require more cleaning and maintenance. The dimensions marked with an asterisk symbol (*) indicate the minimum dimensions for the maintenance area.

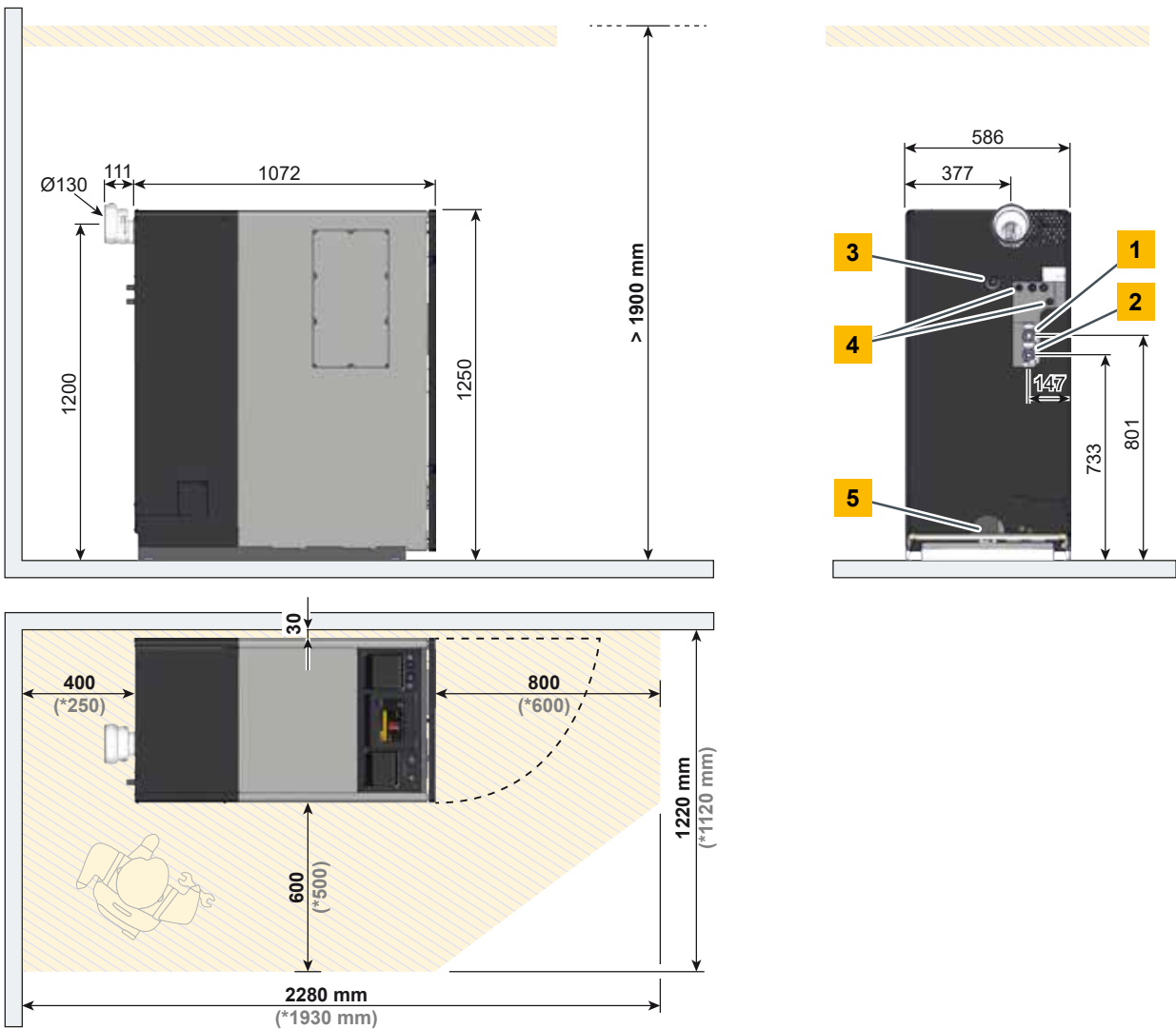

The optional eTWIN pellet burner can only be mounted on the left side of the boiler. If the eTWIN pellet burner is to be retrofitted, the additional space required for the pellet burner is to be taken into account when setting up the log boiler.





Log boiler eSH	Unit	16	20
Rated capacity	kW	16	20
Efficiency at partial load (=values with integrated precipitator)	%	94.3 (94.7)	94.2 (94.1)
Energy efficiency class "package-system"		A++	A++
Fuel chamber	mm	560 mm deep for 0.5 m logs 422 x 322 mm door opening	
Fuel chamber volume	litres	102	
Transport dimensions W x D x H	mm	586 x 1102 x 1250	
Weight	kg	460	460
Water content	litres	69	
Required flue draught A draught limiter is recommended above 25 Pa.	Pa	> 5	
Electrical power consumption at full load (=values with integrated precipitator)	W	31 (67)	33 (58)
Recommended buffer volume	litres	> 1100, optimal 1650	
Required buffer volume in Germany (1st BimschV / German Federal Immission Protection Ordinance)	litres	880	1100
Maximum permissible operating pressure	bar	3	
Temperature adjustment range	°C	70 - 85	
Maximum permissible operating temperature	°C	85	
Boiler class		5 according to EN 303-5	
Suitable fuels		Logs EN ISO 17225-5, with maximum 20% water content	
Electrical connection		1 x 230 V / 50 Hz / 13 A	
Mode of operation		non-condensing	

Subject to technical changes and errors

Complies with
EU standards



Austrian Ecolabel



ETA eSH-TWIN combination boiler

- 1** Flow, 1" ball valve
- 2** Return, 1" ball valve
- 3** Connection for safety valve, pressure gauge and bleed valve R3/4" internal thread
- 4** Safety heat exchanger R1/2" external threads
- 5** Filling and draining valve
- 6** Pellet suction hose DN50
- 7** Pellet return air DN50

Optimum maintenance area. Fixed components (e.g. expansion tank, hot water tank) in this area may require more cleaning and maintenance. The dimensions marked with an asterisk symbol (*) indicate the minimum dimensions for the maintenance area.

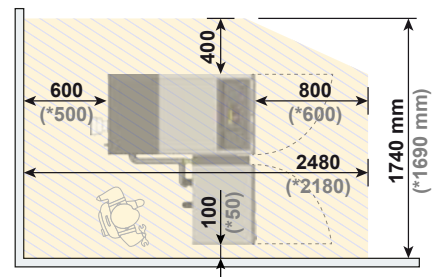
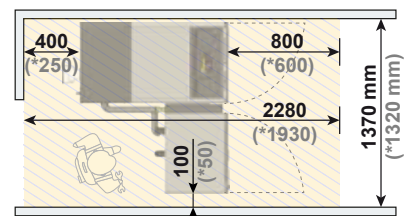
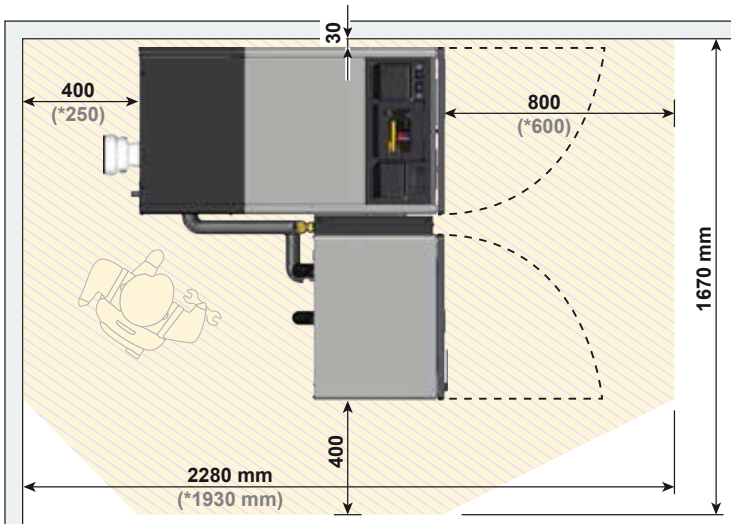
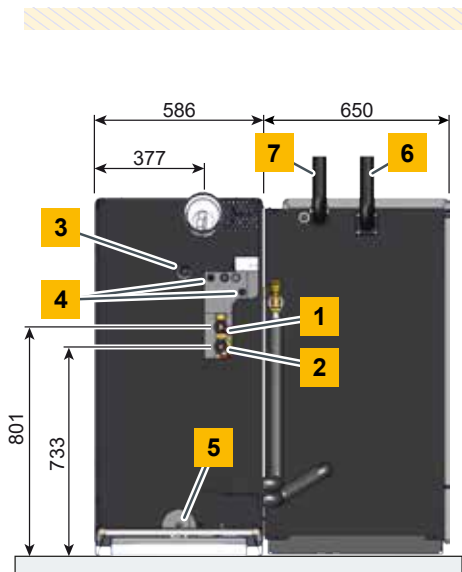
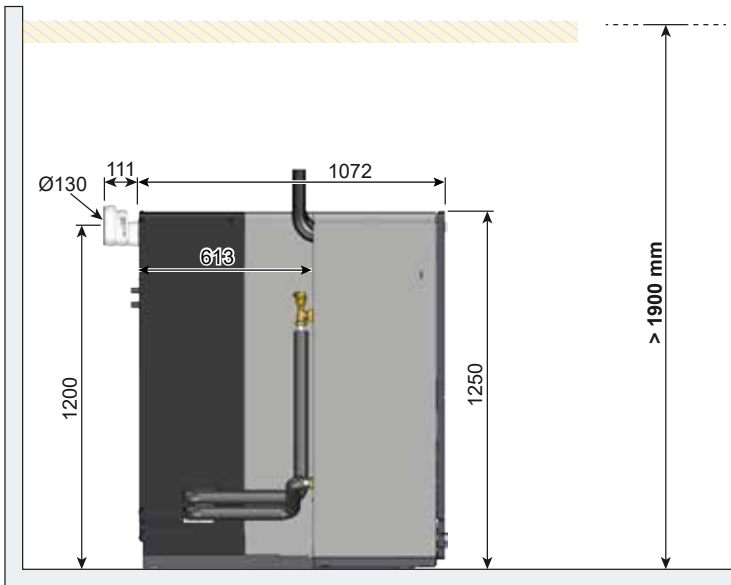



Combination boiler eSH-TWIN	Einheit	16
Rated heat capacity pellet burner eTWIN	kW	4.8 - 16
Rated heat capacity log boiler eSH	kW	16
Efficiency pellet burner at partial/full load	%	92.6 / 94.5
Efficiency log boiler at partial/full load	%	94.3
Energy efficiency class "package-system"		A++
Fuel chamber log boiler eSH	mm	560 mm deep for 0.5 m logs 422 x 322 mm door opening
Fuel chamber volume log boiler eSH	litres	102
Transport dimensions W x D x H pellet burner eTWIN	mm	740 x 546 x 1494
Transport dimensions W x D x H log boiler eSH	mm	586 x 1102 x 1250
Weight pellet burner eTWIN	kg	146
Weight log boiler eSH	kg	460
Water content pellet burner eTWIN	litres	13.9
Water content log boiler eSH	litres	69
Pellet bin on boiler (net)	kg	33 kg (162 kWh)
Maximum distance to pellet store	m	20
Ash box volume	litres	15
Required flue draught A draught limiter is recommended above 25 Pa.	Pa	> 5
Recommended buffer volume	litres	> 1100, optimal 1650
Maximum permissible operating pressure	bar	3
Temperature adjustment range	°C	70 - 85
Maximum permissible operating temperature	°C	85
Boiler class		5 according to EN 303-5
Suitable fuels		Logs EN ISO 17225-5, with maximum 20% water content and Pellets EN ISO 17225-2-A1, ENplus-A1
Electrical connection		1 x 230 V / 50 Hz / 13 A
Mode of operation		non-condensing

Subject to technical changes and errors

Complies with
EU standards



Austrian Ecolabel





ETA Pellets boiler

ETA PU PelletsUnit	7 - 15 kW
ETA ePE Pellets boiler	7 - 56 kW
ETA PC PelletsCompact	20 - 105 kW
ETA ePE-K Pellets boiler	100 - 240 kW



ETA Condensing heat technology

ETA ePE BW Pellets boiler	8 - 62 kW
ETA BW Condensing heat exchanger PU	7 - 15 kW
ETA BW condensing heat exchanger PC	20 - 105 kW



ETA SH Log wood boiler and TWIN Pellets boiler

ETA eSH Log wood boiler	16 - 40 kW
ETA eSH-TWIN Combination boiler with ETA eTWIN Pellets boiler	16 - 40 kW
ETA SH Log wood boiler	16 - 32 kW
ETA SH Log wood boiler	20 - 60 kW
ETA SH-P Log wood boiler with ETA TWIN Pellets boiler	20 - 60 kW
	20 - 50 kW



ETA Wood chip boiler

ETA eHACK Wood chip boiler	20 - 240 kW
ETA HACK VR Wood chip boiler	250 - 500 kW

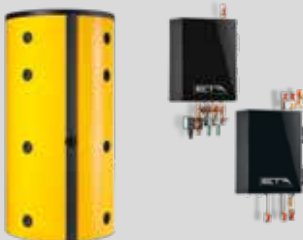

ETA Buffer tank

ETA Buffer	500 l
ETA Buffer SP	600 - 5.000 l
ETA Buffer SPS	600 - 1.100 l

ETA Hydraulic modules

ETA Fresh water module
ETA Stratified charging module
ETA System separation module
ETA Mixing circuit module
ETA Heat transfer module and station

Your heating specialist will be happy to advise you:



ETA Heiztechnik GmbH
 Gewerbepark 1
 A-4716 Hofkirchen an der Trattnach
 Tel.: +43 7734 2288
 Fax: +43 7734 2288-22
 info@eta.co.at
 www.eta.co.at

Technical changes and mistakes reserved

In order to provide you the benefits of our continuous development, we reserve the right to change specifications without prior notice. Printing and typesetting errors or changes of any kind made in the interim are not cause for claims. Individual configurations depicted or described here are only available as options. In the event of discrepancies between individual documents regarding the scope of delivery, the information provided in our current price list shall prevail. Images and symbols may contain options that are available for an additional cost.

Photo source: ETA Heiztechnik GmbH, Lothar Prokop Photographie, istockphoto, Thinkstockphotos, Photocase, Shutterstock.
 94401-EN, Prospekt eSH-TWIN ETA EN, 2025-02

