

ETA ePE-K  
100 to 240 kW

  
... my heating system



The powerful pellet boiler for companies  
and residential construction



*A passion for perfection.*  
[www.eta.co.at](http://www.eta.co.at)



*The ETA ePE-K is ideal for large apartment blocks, residential buildings, commercial operations and for small local heating networks.*

## Ideal for new builds and renovations

The heating requirements in large apartment blocks and industrial buildings are often very high, and so are the ongoing costs for heating and hot water - especially if you still use fossil fuels. The conversion is worth it – especially when it's as easy as with ETA. Already during the development of the ETA ePE-K pellets boiler, the quality company from Upper Austria had not just in new builds, but especially renovations in its sights. So in most cases no large conversion is required for boiler replacements and existing conditions can be used best. For example, a pellet store can be placed up to 20 metres away – for instance there where the oil tank used to stand.

### **Serial quality**

Larger heating requirements are also no problem for the ETA ePE-K. So two, three or even more boilers can be set-up in parallel. This modular or cascade design was perfected by ETA, so that it's not only possible to easily put them into existing properties, but the effort as regards piping, buffer volume, pumps and assembly is also reduced to a minimum.

### **Everything under control everywhere**

The heart of the efficient heating system is the control system, into which even a solar heating system or a small local heating network can be integrated. The boiler features active monitoring of all functions and remote maintenance via GSM and internet, making it ideal for contracting use.

### **Active control for dependability**

Safe operation is ensured by the comprehensive measurement and reporting of the most varied of boiler data, such as the draught fan speed, power consumption of screw motors, air flap position, residual oxygen in flue gas, return riser, exhaust temperature or hot water temperature.

# A win-win situation

Save heating costs, boost your domestic economy and help the environment in the process: heating with pellets pays off. Currently, around 7 million cubic metres of excess wood is growing in Austria - and forested areas are increasing across the whole of Europe.

## Using resources sensibly

In contrast to fuels such as oil and gas, pellets hardly effect the climate. That is because trees absorb as much CO<sub>2</sub> during growth as they later release during combustion. In addition, the CO<sub>2</sub> released when burning is equal to or less than that of naturally rotting wood.

about 30 kg **CO<sub>2</sub>** are emitted when you

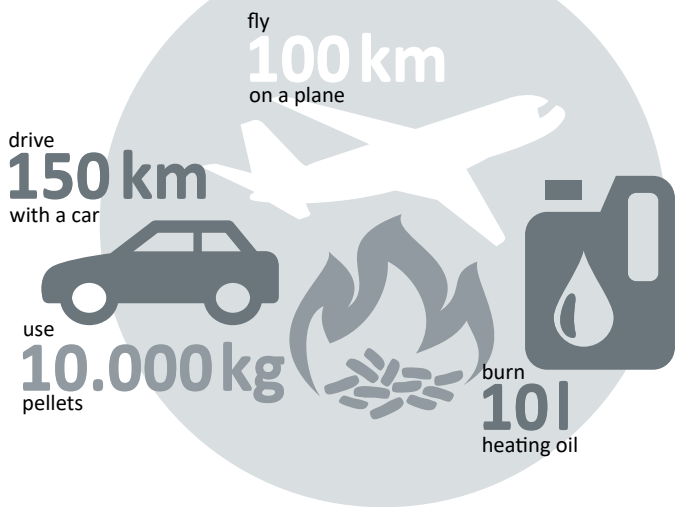

## Wood cutting in the sawmill

100% softwood\* (without bark) consisting of:

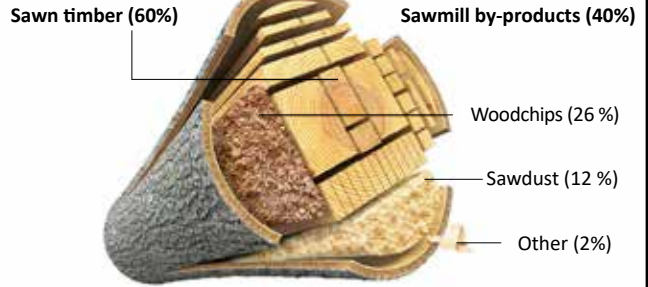

\*More than 95% of sawmill products in German sawmills are made of softwood.  
Source: Döring, P.; Mantau, U: Standorte der Holzwirtschaft - Sägeindustrie - Einschnitt und Sägebrennprodukte 2010. Hamburg, 2012.  
Conversion: DEPI. German Pellet Institute, using images from mipan / 123RF.com and Can Stock Photo / dusan694

*No extra trees have to be felled to produce pellets, because the wooden briquettes consist mainly of sawdust, a waste product of the wood industry.*

## Price development of energy sources

for households 2004 - 2024

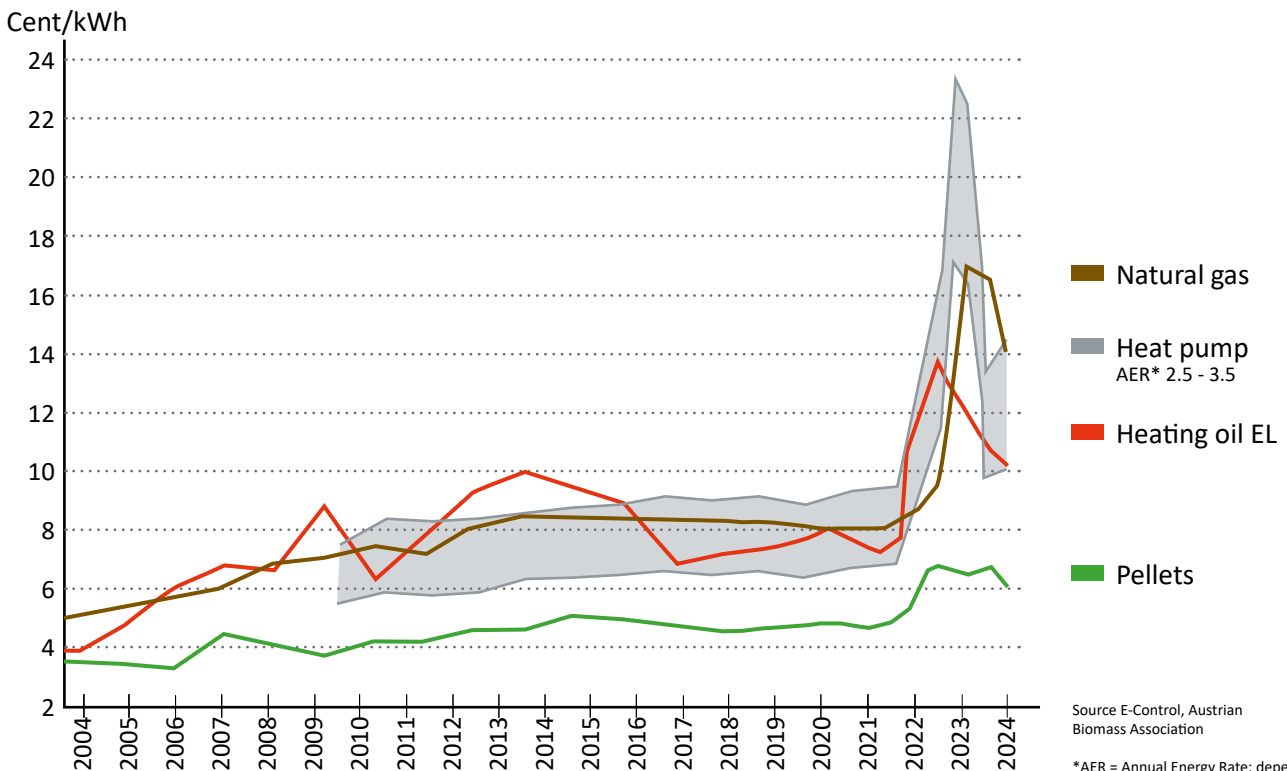

Source E-Control, Austrian Biomass Association

\*AER = Annual Energy Rate: depending on the existing building

# Always space for pellets

The pellet store can easily be set up anywhere where an oil tank stood before. It doesn't even have to be near the boiler, but can be situated up to 20 m and two storeys away. If there's no space in the house, the store room can also be set-up in an adjacent building, or an underground tank can be used. The store room just needs to be dry so that the pellets don't swell up. Wooden cladding can help in rather damp rooms.

## A clean solution

The wood pellets, which are pressed from the waste products of the wood industry, are delivered by tanker and blown into the store room. So the delivery of pellets is an extremely clean process. If the store is sealed then no dust can escape here either.



## How big does my store room have to be?

The approximate pellet requirement per year in tonnes is calculated by dividing the heating load in kilowatts by 3. To calculate the pellet requirement in cubic metres, divide the heating load by 2. So, for example, for 30 kW heating load you need approx. 15 m<sup>3</sup> or 10 tonnes pellets per year. When moving from another energy source, the pellet requirement can also be determined from the previous consumption.

1 ton of pellets roughly corresponds to:

- 500 l heating oil
- 520 m<sup>3</sup> natural gas
- 750 l liquid gas
- 600 kg coke (fuel)
- 1,400 kWh power with geothermal energy pumps (coefficient of performance 3.4)
- 2,000 kWh power with air heat pumps (coefficient of performance 2,5)

## How do the pellets get to the boiler?

### Discharge screw:

It stretches the entire length of the store room, can be up to 6 m long and transports the pellets from the store room to the transport hoses, which lead to the boiler. From here, the pellets are conveyed further with a vacuum motor. After transport the hoses are vacuumed empty. Hence they do not clog up and always work with the highest degree of efficiency. With this standard system, the store room can be completely emptied.

Over the inclined smooth floor, the pellets automatically slide into the transport screw. The impact protection mat is suspended opposite the filling nozzles, so that the pellets do not shatter on the wall when they are blown into the store room from the truck. The prerequisite for this construction is that the connections for the transport hoses to the boiler are located on the narrow side of the store room, so that the whole length of the room can be utilised with the screw.

With the ETA System, pellet transport goes particularly quickly, the suction times are very short.

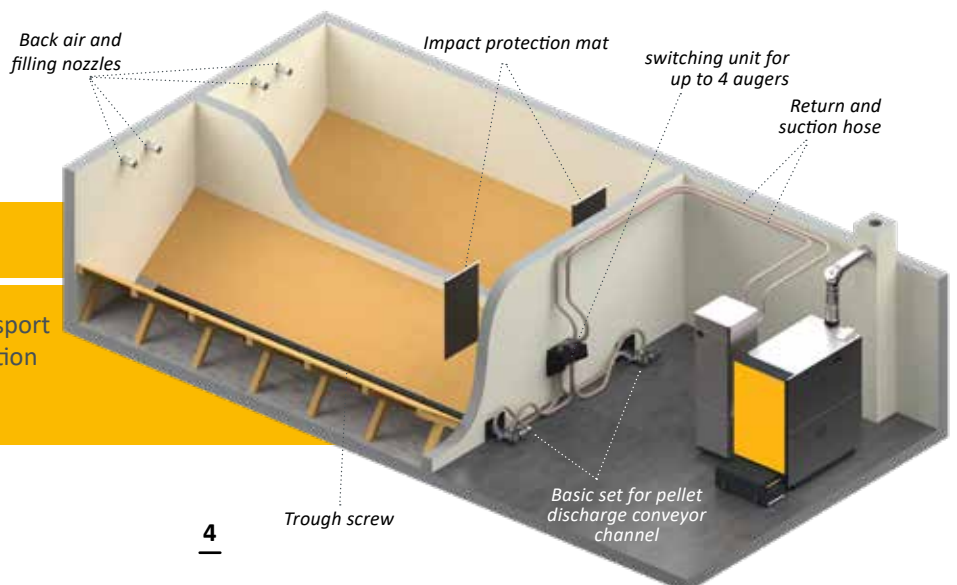

**Suction probes:**

If the shape of the room is not suitable for a discharge screw, the ETA suction probe system is the ideal choice. Here, the pellets slide over the slanting and smooth wooden floor directly to the four suction probes, which alternately transport pellets away from the store room. Through automatic changeover, the fuel supply is not interrupted if a probe doesn't get any pellets at a certain point in time. The prerequisite for this system is that the

store room is situated opposite the boiler in the same storey or higher, and that the store room is no longer than 4 m. Unlike screws, the suction probes do not fully empty the store room. When the storage room capacity is tight, this can be a disadvantage. The advantage is that this system can be used even in angled store rooms.

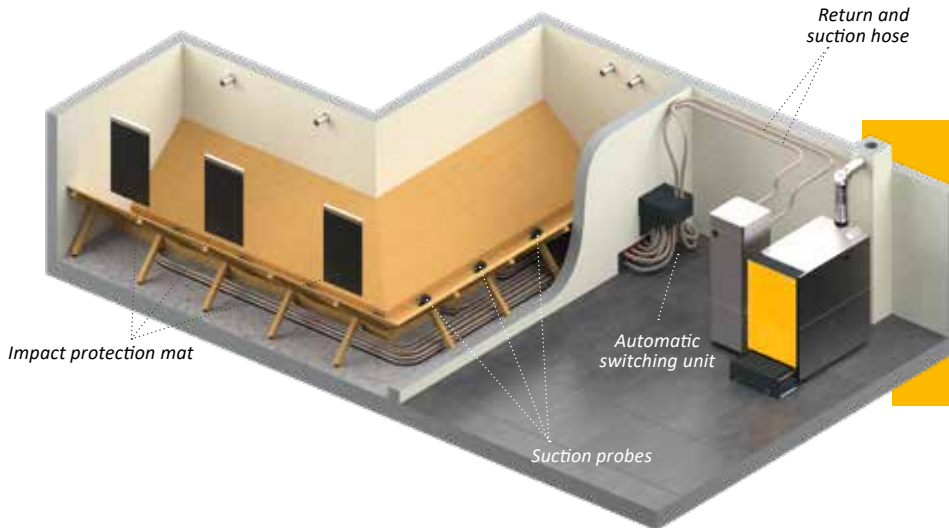

With the suction probes, nearly all rooms can be used as a pellet store, even if it's angular. Eight probes are also possible with larger store rooms.

**Mole conveying system:**

Due to the structural constraints, conventional ETA pellet conveying systems may have some limitations in terms of usable pellet storage volume. The high quality E3 mole conveying system is a useful application in this situation.

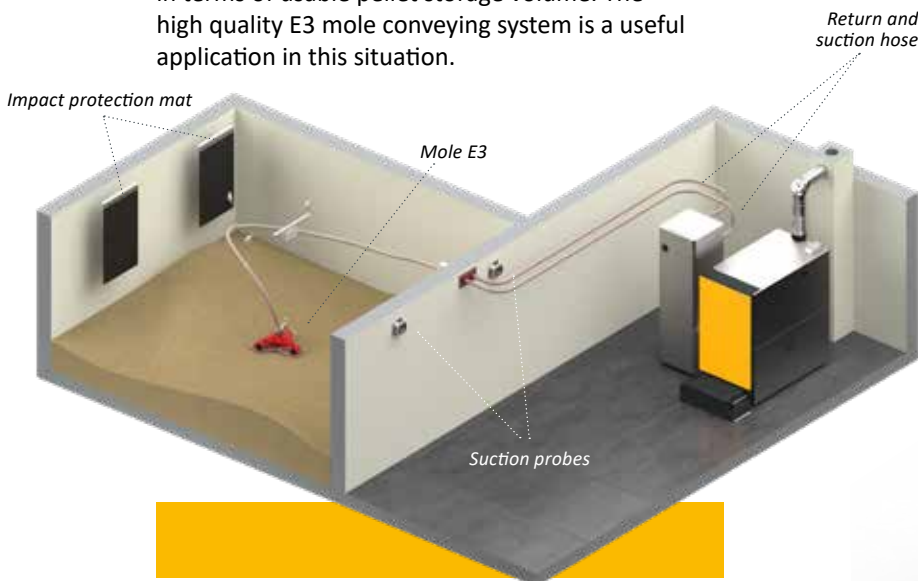

With the E3 mole conveying system, the storage space can be almost completely emptied and the sloping wooden structure is eliminated.



**ETA tip: storage in the ETA Box**

One particularly practical solution is the ETAbox. It can be set up in the boiler room, in an attic, in a barn or – if covered – even outside. It even keeps the pellets dry in damp rooms. Distances of up to 20 metres of suction hose stretching from the box to the boiler are no problem. Please note that the ETAbox cannot be set up directly on a wall. This is why the space required is a bit larger compared to a brick store with the same capacity.



# Heat, just the way you need it

The ETA ePE-K doesn't just produce heat, the ETA System also distributes it efficiently. Rely on the perfect control centre for your heating and hot water system.

The ETA ePE-K is equipped with a control system for the entire heating system. Whether you want to integrate a solar heating system, a conventional hot water preparation system or a buffer storage tank with fresh water module, whether the energy is transferred with radiators or via underfloor heating: You've got everything under control via a touchscreen on the boiler or also via computer or smartphone. Simple images show you if your solar heating system was successful or how full your buffer is.

## With buffer, please

ETA buffer storage tank is a perfect partner. Above all, when heating in fall or in spring and for hot water preparation in the summer, often less energy is needed than what the heating boiler produces. The buffer stores this excess heat and releases it on

demand. This saves fuel and protects the boiler, because fewer boiler starts are needed.

The ETA stratified buffer is ideal for the integration of a solar heating system. In summer, hot water can be produced at virtually no operating costs. But in winter, the solar collectors seldom produce the 60 °C that are common for hot water preparation. Then the water that is heated by solar energy is fed through the underfloor heating. This usually works with hot water temperatures of just 30 to 40 °C.

The ETA stratified buffer can also be equipped with a fresh water module, which constantly reheats the tap water with the help of a heat exchanger. Thus the risk of germs and bacteria is minimised.

*Remote controlled via the meinETA communication platform.*



*The ETA mixing circuit module for two heating circuits saves a lot of time and money during installation, as no sensor lines, pumps and mixer cables have to be installed.*



*integrated return riser*

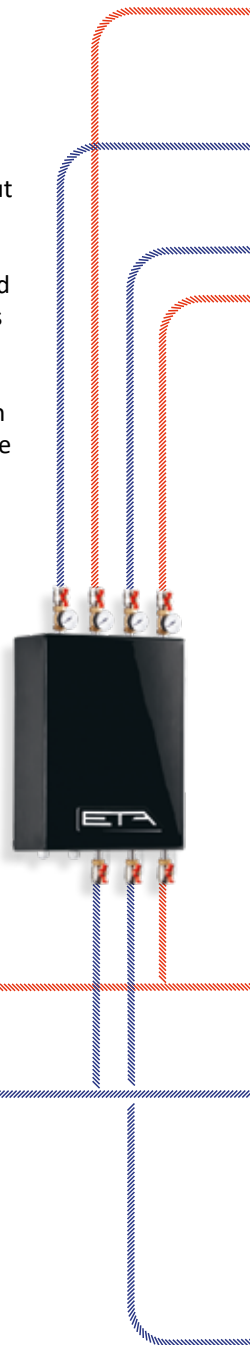

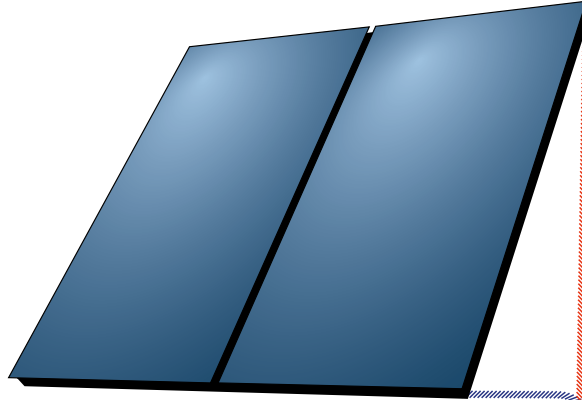

*For smaller solar heating systems with large buffer storage tank volumes or for very large solar heating systems, the ETA stratified charging module ensures maximum efficiency.*

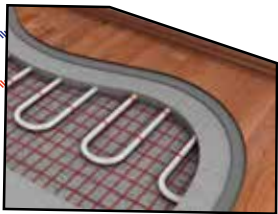

**Everything at a glance!**  
The ETA room sensor displays the room as well as the outside temperature and enables easy changing of the desired room temperature.

*The ETA stratified buffer can also be equipped with a fresh water module, which constantly reheats the tap water with the help of a heat exchanger. Thus the risk of germs and bacteria is minimised.*

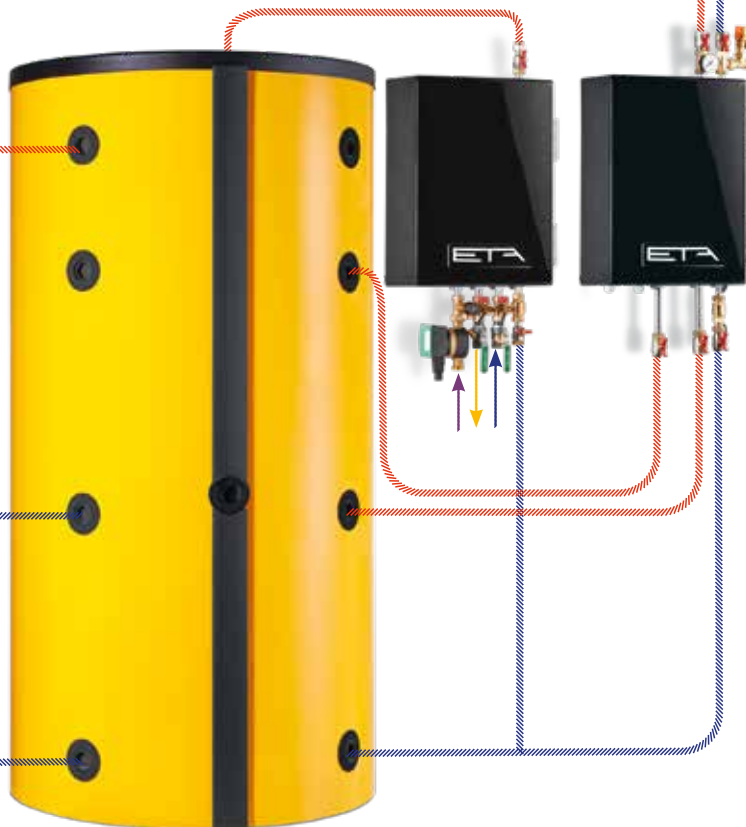

*An ETA stratified buffer is the ideal addition to ePE-K. It stores energy that is not required and delivers on demand.*



## Cleanliness yields the highest efficiency

In ETA systems, the combustion chamber and heat exchanger are automatically cleaned as a whole. This increases the efficiency and minimises the maintenance effort for the boiler. Eventually the ash box must be emptied – thanks to ash compression and large volume of the ash box less frequently than with conventional systems.

### Automatic de-ashing: conclusively progressive

As the screw for de-ashing is about the same size as the stoker screw, foreign bodies such as stones or nails in the ash are no problem either. The screw can also easily be taken out from the front.

**Heat exchanger cleaning: permanently high efficiency.** A special dampened mechanism cleans the heat exchanger pipes and allows fly ash to fall down with a return movement. Even the optionally integrated precipitator uses this mechanism for its cleaning. That is clean and efficient! The falling ash is largely picked up from the boiler floor via a mini moving floor and fed to a screw placed in the centre.

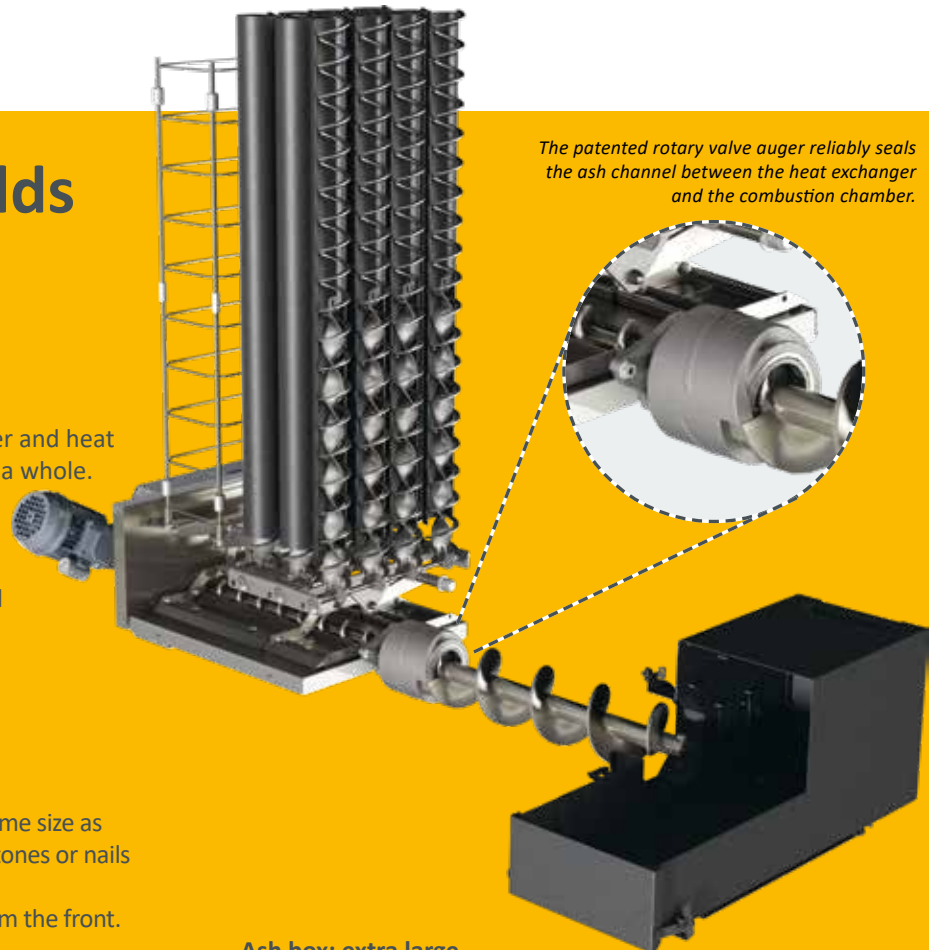

*The patented rotary valve auger reliably seals the ash channel between the heat exchanger and the combustion chamber.*

**Ash box: extra large, but practical to empty.** Ash is conveyed fully automatically into an external ash box. The de-ashing screw compresses the ash and extends the emptying interval significantly in comparison with other systems. The box is best transported with a handcart. A guide plate on the box ensures correct transport, even if it's uneven at times. For simplified discharge, the front cover with the robust lock can be completely removed. So when emptying, the box fits virtually all bins or containers.

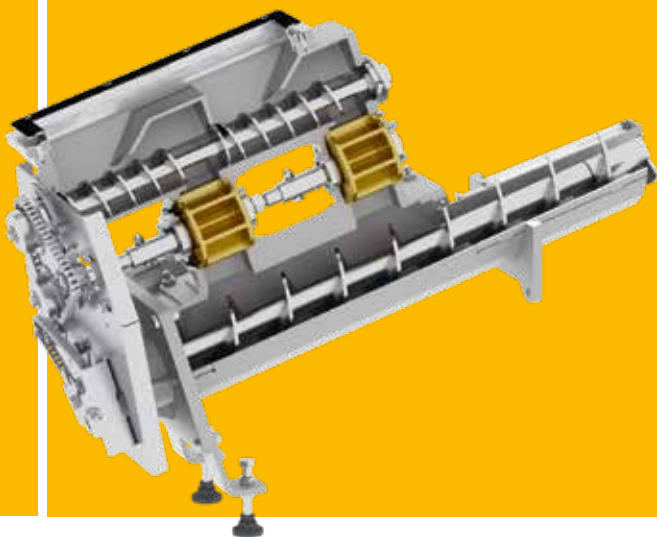

## Rotary valve

**The safe system.** The rotary valve absolutely protects you from burn-back: Burning should only take place in the combustion chamber and nowhere else. A transport screw brings the pellets to the rotary valve – and only as many as the rotary valve can handle. This is why the pellets do not become wedged, crushed or broken. Thanks to this system developed by ETA, the sealed edges of the rotary valve do not wear out. The system remains safe throughout the entire service life of the boiler.





## Intelligent technology in the combustion chamber

**Optimal fuel utilization.** The fuel is pushed from the side to the segment rotating grate in the combustion chamber and subjected to controlled burning there. The refractory-lined combustion chamber with controlled air flow enables a high combustion temperature and thus optimal fuel utilization. Once the material is completely burnt out, the segment grate turns a full 360°. Foreign bodies such as nails and stone safely fall through onto the ash screw which lies beneath. Through the patented rake above the combustion chamber, now the secondary combustion chamber is also de-ashed completely automatically, which increases the efficiency of the boiler and ensures lower flue gas temperatures at the same time.

**Overfill protection.** This is an important safety measure that ensures that no more fuel is in the chamber that could be combusted. Even if the boiler is cold or wet after a prolonged standstill, or a difficult-to-ignite fuel is used, overfilling of the boiler cannot happen, and thus deflagration is prevented. The sensor-controlled firebed control system always ensures the correct fuel quantity. This is an advantage for alternative fuels such as pellets, but also for very dry wood chips.



**Optimised ignition saves energy.** With short combustion breaks, the refractory-lined combustion chamber still remains hot enough that any new fuel which is fed in can be ignited by remaining embers. The noiseless ignition is only used after prolonged boiler standstills. The ignition fan is deactivated as soon as the lambda probe and exhaust temperature sensor signal that ignition was successful. That saves energy!

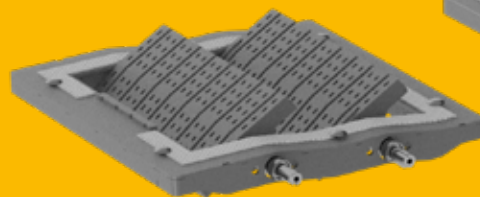

ePE-K 100 - 170 kW

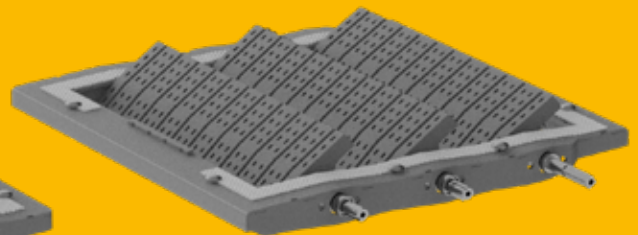

ePE-K 180 - 240 kW

## Safely with negative pressure

**EC draught fan.** Quiet as a whisper, this speed-controlled fan ensures constant underpressure in the boiler. It works very economically thanks to EC motor technology. Additionally, the draught fan ensures oxygen supply in the combustion chamber and therefore for ideal burning behaviour and best utilisation of the fuel. Through the sophisticated boiler construction, the draught fan produces sufficient underpressure in the boiler, so that, contrary to conventional systems, no additional pressure fan is needed. The underpressure sensor provides for even more efficient control of the draught fan. This measures the negative pressure in the boiler and optimises the air supply in the combustion chamber. This minimises operating costs!



## Lambda probe

**It's all about the mix.** With help of the lambda probe, the mixing ratio of fuel and oxygen is perfectly coordinated, so different fuel qualities always achieve the best possible efficiency. In addition, the probe immediately detects if the ignition was successful. This reduces the ignition time and saves power and money.



*The lambda probe is an important part of the combustion technology. In conjunction with the ETA combustion control system, it determines the course and quality of combustion.*



## 7" touchscreen

A capacitive 16:9 format touchscreen with a robust and non-sensitive glass panel now also reacts without pressure making it's operation easier. The display can also be tilted for easier viewing.



## Integrated return riser

This ensures quick, space- and cost-saving assembly, as all components are checked and cabled at the factory. A pressure sensor to monitor the water pressure is already installed and an additional connection enables an optimum connection of the safety group.

## Pellet hopper directly on the boiler

The pellet hopper with a capacity of 220 kg is sized to operate at full output for at least approx. 5 hours without having to suck in pellets during this time.

The required negative pressure for suction of the pellets is ensured by a vacuum turbine for industrial applications.

With a brushless EC motor, it is extremely low wear and reliable in operation.

The pellets are sucked up by high-quality reinforced hoses, which also have an increased suction volume despite the standard diameter of 50 mm.



## Optional precipitator

### Clever use of a natural phenomenon

Why does dust keep building up on the computer screen? It's because the dust particles are electrostatically charged and are attracted by the screen – ETA makes use of this effect in its precipitator. With the aid of an electrode in the flue gas duct the particles which are swirling in the flue gas are energised and ionised. This results in the particles being deposited on the internal wall of the separator and no longer escaping from the chimney with the flue gases.

The precipitator is cleaned completely automatically during de-ashing. The dust then lands in the front ash box along with the remaining ash from the boiler.

As the precipitator can be integrated into the eHack, nothing stands in the way of a retrofit and no additional space has to be planned in the boiler room.

With a degree of separation of 80-85%, even for poor fuel the precipitator ensures low dust emission at minimum power consumption.



## External de-ashing systems

To achieve even larger de-ashing intervals, ETA offers a de-ashing extension in external containers. The extension can be placed to the left or right of, as well as in front of or next to the boiler! Not only does this

system offer planning flexibility, it also saves a lot of space thanks to the specially designed coreless screw system.

### Ash bins with 240 l or 320 l capacity

#### 240 litres

The hot-galvanized steel container has wheels for easier removal, meets the requirements of EN 840, and is suitable for removal by a disposal company.



240 Liter

#### 320 litres

The flap located in the bottom of the container provides a convenient discharge. Using a pallet fork, the container can be transported with front loader or forklift.

The bottom flap is unlocked when the container is either on the wheels or is secured by suitable means. After unlocking, the container can be moved slowly upwards to gently open the flap and minimize the formation of dust.



320 Liter

## The way to heat

From the pellet hopper through to the combustion chamber and to the heat distribution system: the interplay of high-quality components is in demand!

- 1 Vacuum turbine:** It transports the pellets from the store room to the intermediate container of the boiler.
- 2 Pellet hopper:** The pellets are stored here temporarily and are immediately available for combustion.
- 3 Rotary valve as burn-back protection device:** It is the completely sealed closing door between store and ignition and therefore safely protects against burn-back.
- 4 Clean combustion chamber:** In order to completely empty the combustion chamber from ash, the segment grate automatically rotates 360°, the ash can fall down without friction.
- 5 Primary and secondary air flap:** Both flaps are controlled via the lambda probe so that the ideal amount of air reaches the combustion chamber for the combustion. The automatic signal calibration ensures that the current data is always processed from the lambda probe and thus that the highest efficiency is continuously achieved.
- 6 Fully automatic ash removal in an external ash box:** The ash from the combustion chamber, heat exchanger and the optional precipitator is transported and compressed to the ash box via the ash screw. This ensures long deashing intervals and comfort.

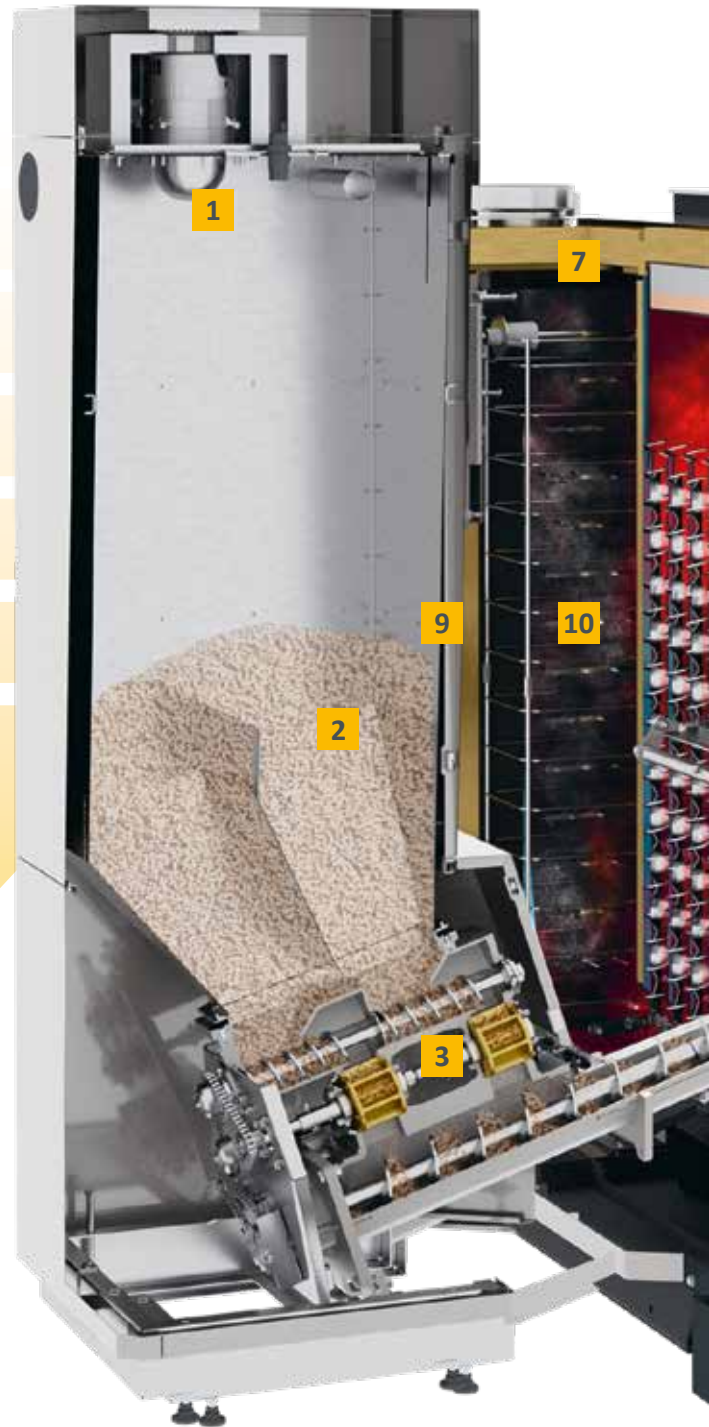

The way through the boiler:

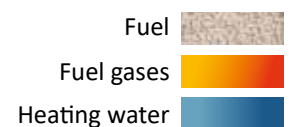

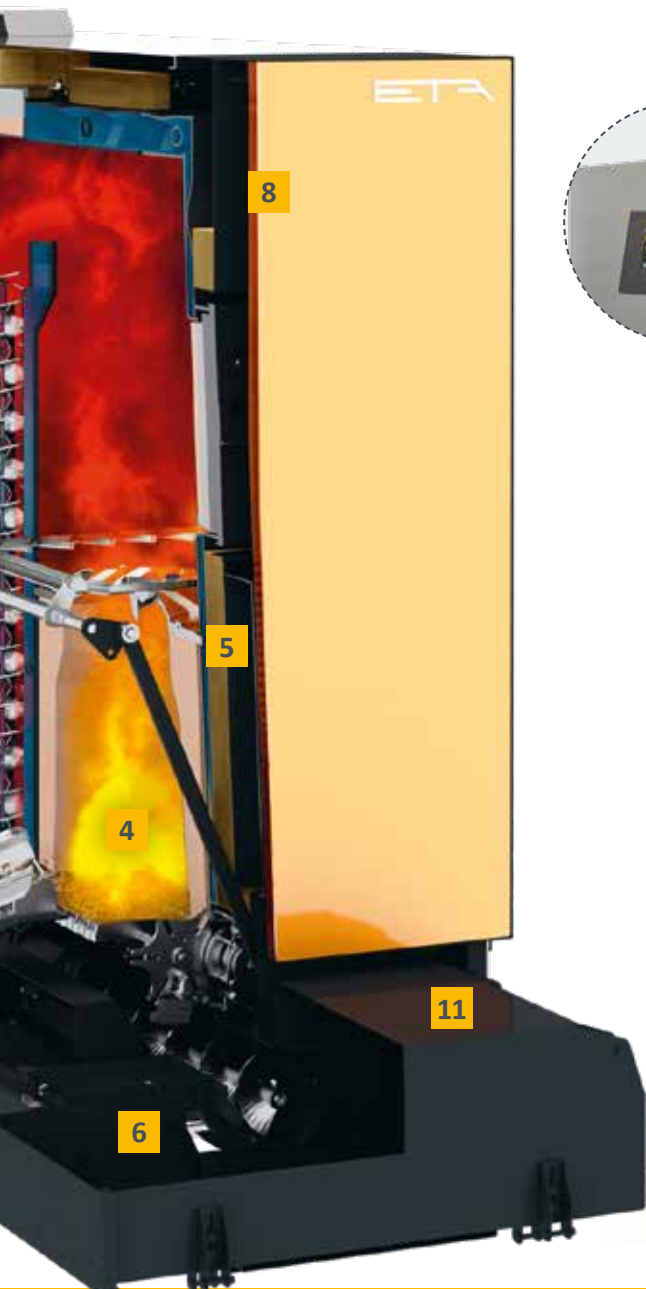

**7 Draught fan:** Whisper-quiet, this fan ensures negative pressure in the boiler. In addition, it regulates the amount of air and thus ensures safety in the boiler room.

**8 Touch control system with microprocessors:** With just a few swipes of your finger you intuitively control the whole menu. If your boiler is connected to the internet, it tells you by email when the ash box has to be emptied, for example. Furthermore, you can use the free communication platform meinETA with partner network as well as free software updates via USB connection.

**9 Integrated return riser:** ensures a quick, space- and cost-saving installation.

**10 Heat exchanger cleaning:** The heat exchanger is fully automatically cleaned with turbulators. This ensures constantly high efficiency.

**11 External ash box:** The ash is compressed so that the ash box must be emptied less frequently than in conventional systems. It is easy and convenient to access.

## Simple and can be controlled from anywhere

Good technology is characterized by being user-friendly. You don't have to be a technician to use ETAtouch's many functions.

### ETAtouch: the touchscreen as heating control

The days of confusingly arranged buttons and controls are over, because with the touchscreen of the ETA control system you can make all settings conveniently and easily. The icons are self-explanatory. Whether you generally have warmer or cooler temperatures, want to change the time for night setback or want to switch to setback mode during your vacation - you will intuitively tap on the right illustration without any operating instructions!

You can control your heating system via touchscreen and also have an overview of all integrated components such as buffer tanks, solar systems or hot water tanks.



*Heating, night setback, Holiday setting: the operation is immediately clear*



### the free of charge internet platform

If your ETA control is connected to the internet, you can view and change all heating settings on your smart phone, tablet or PC. So you have your heating under control, no matter where you are!

When you log in at [www.meinETA.at](http://www.meinETA.at), you will see the touchscreen exactly as if you were standing directly in front of the boiler. If necessary, mein-ETA will also inform you free of charge by email about your heating system.

Within your own house network, direct access to the ETAtouch control of your heating system can also be achieved via VNC.

### Quick help

Give your installer temporary access rights to your meinETA account. This way he can prepare for his visit to you. And maybe the technician doesn't even have to come because, thanks to myETA, he can tell you over the phone what you need to do to ensure that your heating system is optimally adjusted. You can see who can access your control via the status display. You always decide who belongs to your partner network!



### For tablets, smartphones and PCs

meinETA runs on all common operating systems such as iOS or Android. meinETA can be loaded via PC using any modern internet browser.





Everything is very simple



**Perfect for your smart home**

The ETAtouch control can be easily integrated into common smart home systems as well as into a building management system (BMS). The mini server of the Loxone system exchanges data directly with the boiler via a ModbusTCP interface. And all you need to connect to a KNX bus system is the optionally available ETA KNX interface and a few simple clicks.

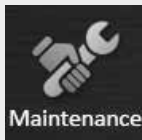

# Maintenance assistant

Simply maintain your boiler yourself: the instructions on the boiler's touch display guide you step by step through the annual cleaning.

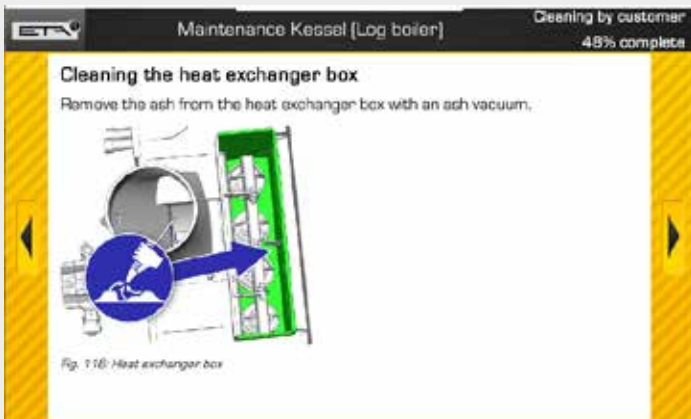

**ETA individual room control interface example:**

Whether Loxone, KNX or ETA individual room sensor with or without display: everything can be controlled via ETAtouch. It always passes on the correct signals to the valve controllers, which control how much hot water should come through to the respective room or heating section.

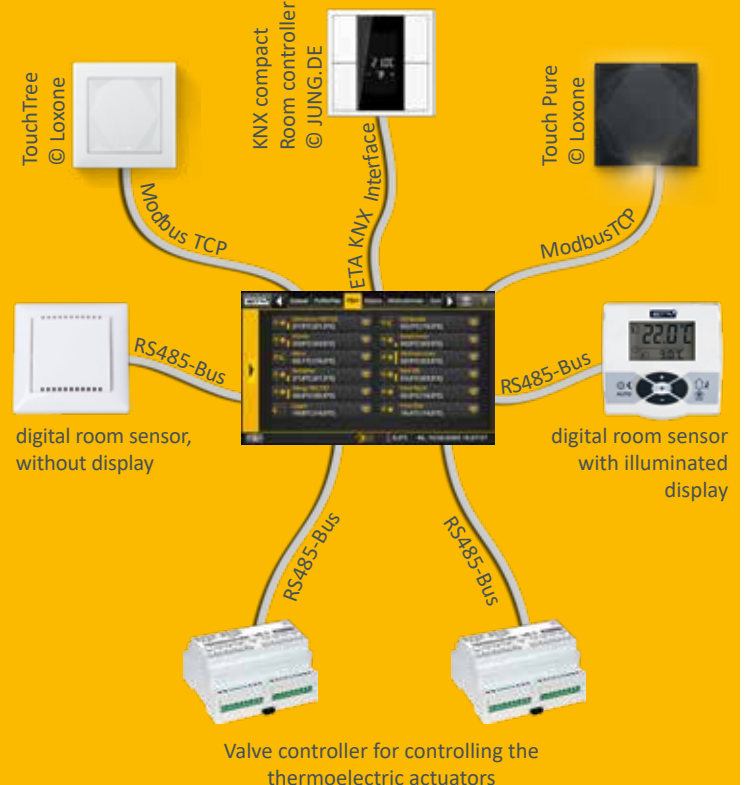

# Everything on one display: the ETA Standard

A modern heating system is only effective if it is well-controlled. ETAtouch takes care of that.

At no added cost, the ETAtouch control system already includes all functions for two heating circuits, hot water supply via tank or instantaneous hot water module, as well as for the integration of a solar heating system. All ETA heating boilers also come with a LAN connection as standard. If you connect the boiler to the internet, you can easily control all components from a PC, tablet or smartphone.

## Boiler and combustion regulation\*

Speed-controlling the several components save power. The lambda and ignition time regulation increases efficiency. All components relevant to operation are monitored.

## Buffer storage tank management\*\*

Three to nine sensors in the tank control the heat generator in the system and distribute the energy to the different consumers. From using five sensors, cascading regulation, QM-Holz and peak load management are part of the ETA Standard.

## Domestic hot water preparation\*

Is made possible both via the ETA instantaneous hot water module but also via the hot water tank or combination tank. For all variants, circulation pumps can be controlled with time and/or requirement programs.

## Solar heating systems\*\*

Single or double circuit solar heating systems with one or two tanks, zone loading via the ETA stratified charging module and also two collector fields as well as three consumers are controlled.

## Two weather-controlled mixing heating circuits\*\*

They run with a weekly program which allows many time windows and automatic and/or manual additional functions. The system can optionally be expanded with room sensors and remote control.



*Comprehensible also without the need for an operating manual: The symbols on the touchscreen are self-explanatory. So controlling the heating system becomes child's play.*

## Additional system functions

Detection of third-party heating devices, such as oil boilers, gas boilers, heat pumps and wood burning stoves, thermostat or differential temperature thermostat, external demand from external devices such as heating fans, control of transmission lines, with or without mixers, and also of heat transfer stations, single room control systems, for example.

## Wall-mounted control box for more complex systems

All control systems can be extended with wall-mounted control boxes, with or without touchscreen.

\* Control system and sensor included in standard delivery scope

\*\* Control system depends on configuration, sensors are available as accessory

# From Hausruckviertel to the world

ETA specialises in the manufacture of biomass heating, i.e. log, pellet and wood chip boilers. The most modern technologies combined with naturally growing resources.

## ETA is efficient

Technicians designate the efficiency of a heating system with the Greek letter  $\eta$ , pronounced „eta“. ETA boilers stand for more heat with less fuel consumption, environmental soundness and sustainability.

## Wood: old but excellent

Wood is our oldest fuel - and our most modern: There is a lot of history - from open fires in front of caves to modern biomass boilers. In the middle of the 20th century, the number of wood heating systems briefly fell. Oil heating became the new, hyped option. A brief interlude in comparison to the consistency of wood. Today, we know that heating with fossil fuel has no future. It contributes to global warming and harms the environment. Supply security is also not guaranteed in the long term, as fossil fuels are being depleted, aren't renewable and often come from unstable regions. While wood by contrast is a cheaper, locally grown, renewable raw material that does not pollute the climate when burnt. No wonder wood heating is booming!

## Comfort with many components

Since December 1998, the Upper Austrian company ETA has been designing and building a new generation of wood-fired boilers. They are full of patented technologies and the most modern control technology – making them easy to use. Convenience and efficiency make ETA products so popular around the world. With a production capacity of up to 35,000 boilers per year and a global export proportion of around 80%, ETA is one of the leading biomass boiler producers.

## You get more than just a boiler

Anyone who decides on a wood or pellet boiler from ETA is choosing sustainability. This is not just in terms of fuel, but encompasses responsibility across the board, with sustainable workplaces in the region. More than 400 employees in Hofkirchen an der Trattnach have the best working conditions – including an in-house restaurant, bright assembly and storage halls, a fitness room and a sauna. There is even a free electric charging station for electric cars, which is supplied by the in-house photovoltaic system. This also covers all the power needed of a production hall and thus saves around 230 tonnes of CO<sub>2</sub> per year.



# Pellet boiler ETA ePE-K 100 - 130 kW

- 1** Connection for safety valve, pressure gauge and bleed valve, R1"
- 2** Flow, 2" ball valve
- 3** Return, 2" ball valve

- 4** Filling and draining valve
- 5** Safety heat exchanger R1/2"

The boiler can optionally be supplied with the pellet module (pellet hopper with stoker) on either the left or the right side.

Optimum maintenance area. Fixed components (e.g. expansion tank, hot water tank) in this area may require more cleaning and maintenance. The dimensions marked with an asterisk symbol (\*) indicate the minimum dimensions for the maintenance area.

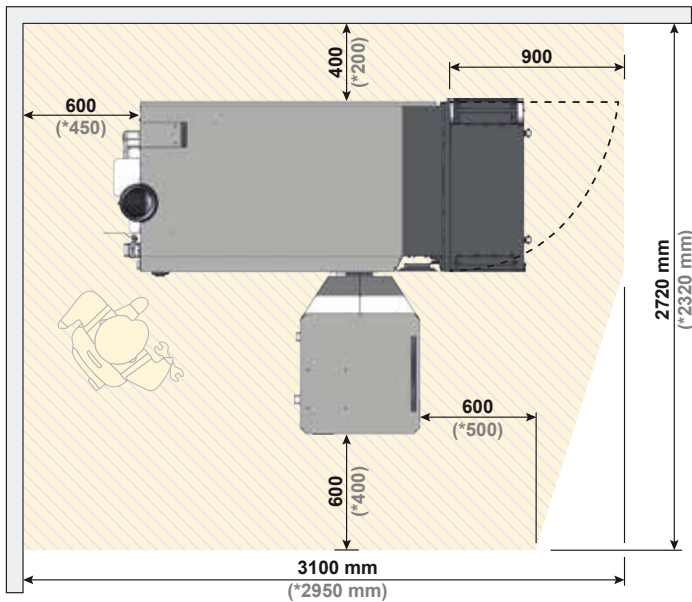
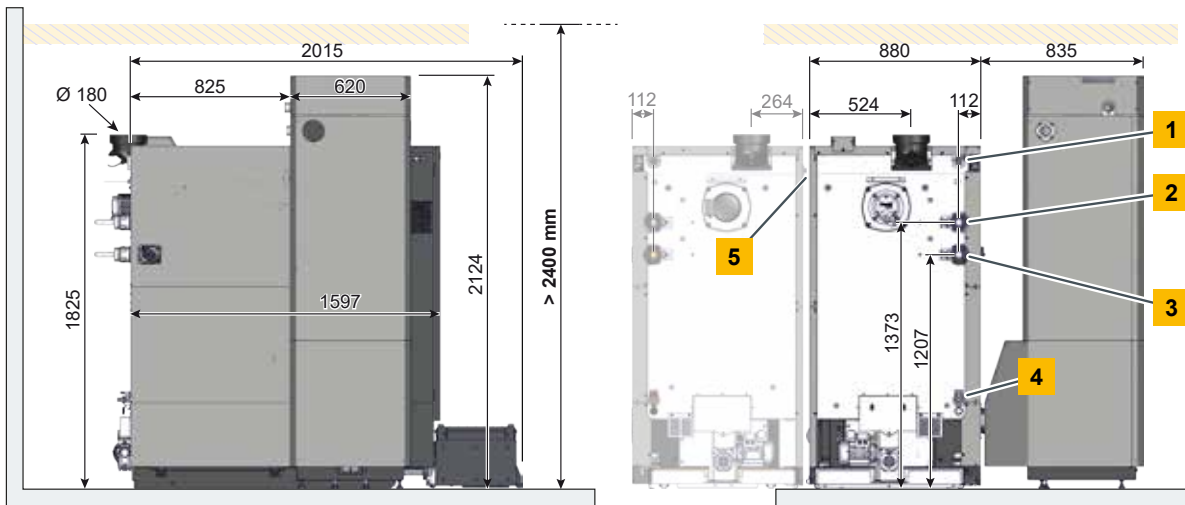



ePE-K Pellet boiler		100	110	120	130
Rated heat capacity	kW	29.9 - 99.9	32.9 - 109.9	35.9 - 119.9	38.9 - 129.9
Efficiency at partial/full load	%	92.7 / 93	92.4 / 93	92 / 92.9	92.3 / 93.1
Transport dimensions (boiler) W x D x H	mm	922 x 1764 x 1825			
Weight of the boiler	kg	1329			
Weight of the pellet module	kg	200			
Water content	litres	272			
Available residual pump head (at $\Delta T = 20K$ ) for buffer operation	mWs	4.5	3.8	3.1	2.5
	m <sup>3</sup> /h	4.3	4.7	5.1	5.5
Pellet bin on boiler (net)	kg	220 kg (1078 kWh)			
Maximum distance to pellet store	m	20			
Ash box volume	litres	94			
Required flue draught Due to the factory-installed flue gas recirculation, a draught limiter is required ( $\leq 15$ Pa).	Pa	> 5			
Electrical power consumption at partial / full load (=values with integrated precipitator)	W	49 / 124 (148 / 211)			
Electrical power consumption in standby	W	13			
Maximum permissible operating pressure	bar	3			
Temperature adjustment range	°C	70 – 90			
Maximum permissible operating temperature	°C	90			
Boiler class		5 according to EN 303-5			
Suitable fuels		Pellets EN ISO 17225-2-A1, ENplus-A1			
Electrical connection		230 V AC / 50 Hz / 16 A			

Subject to technical changes and errors

Complies with  
EU standards



Austrian Ecolabel



# Pelletsboiler ETA ePE-K 140 - 170 kW

- 1** Connection for safety valve, pressure gauge and bleed valve, R1"
- 2** Flow, 2" ball valve
- 3** Return, 2" ball valve

- 4** Return, 2" ball valve
- 5** Safety heat exchanger R1/2"

The boiler can optionally be supplied with the pellet module (pellet hopper with stoker) on either the left or the right side.

Optimum maintenance area. Fixed components (e.g. expansion tank, hot water tank) in this area may require more cleaning and maintenance. The dimensions marked with an asterisk symbol (\*) indicate the minimum dimensions for the maintenance area.

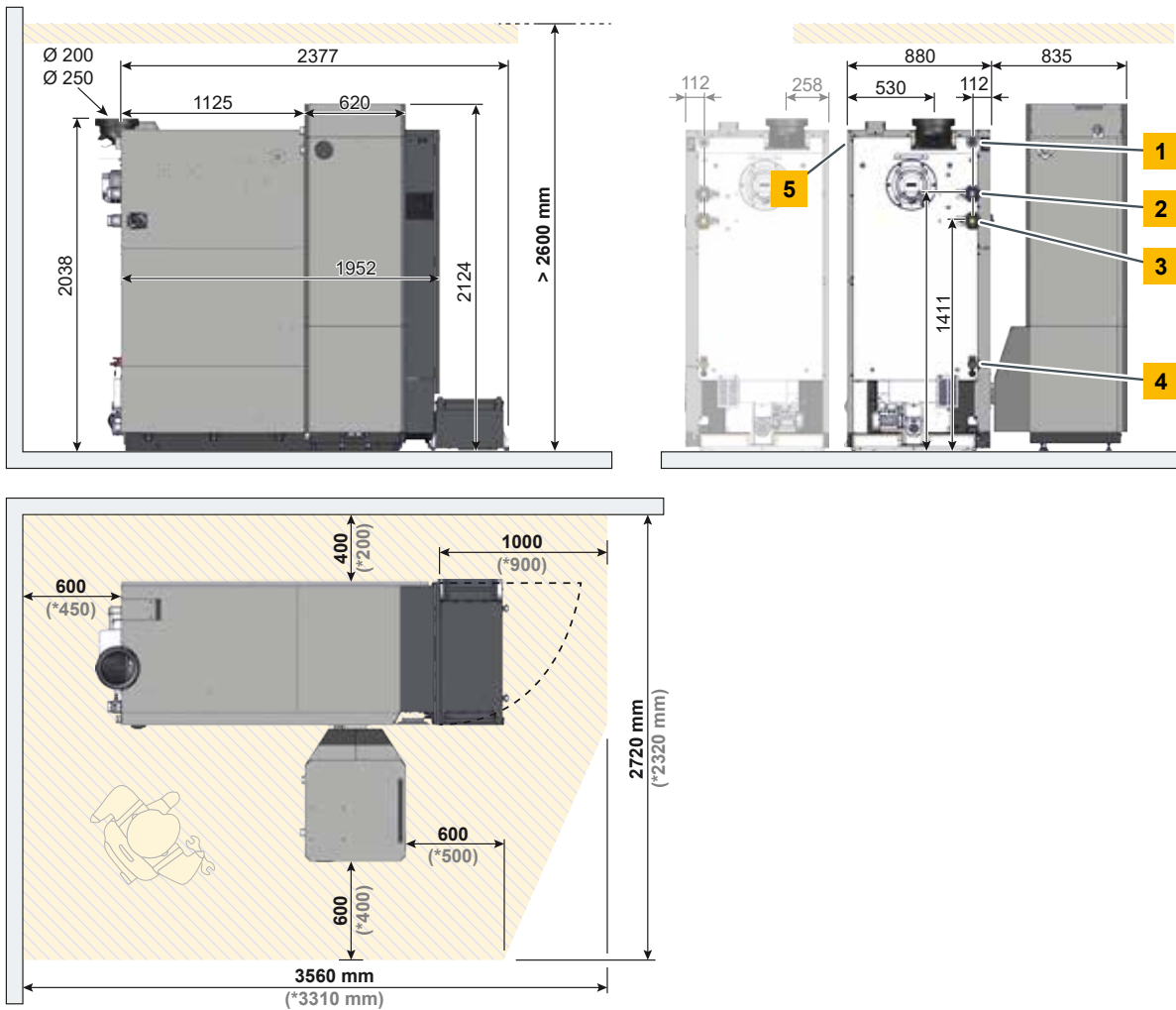



ePE-K Pellet boiler		140	150	160	170
Rated heat capacity	kW	41.9 - 139.9	44.9 - 149.9	47.9 - 159.9	50.9 - 169.9
Efficiency at partial/full load	%	92.8 / 93.4	93.1 / 93.6	93.5 / 93.9	93.9 / 94.1
Transport dimensions (boiler) W x D x H	mm	905 x 2073 x 1970			
Weight of the boiler	kg	1682			
Weight of the pellet module	kg	200			
Water content	litres	347			
Available residual pump head (at $\Delta T = 20K$ ) for buffer operation	mWs	4.8	4.2	3.4	2.7
	m <sup>3</sup> /h	6	6.4	6.8	7.2
Pellet bin on boiler (net)	kg	220 kg (1078 kWh)			
Maximum distance to pellet store	m	20			
Ash box volume	litres	94			
Required flue draught Due to the factory-installed flue gas recirculation, a draught limiter is required ( $\leq 15$ Pa).	Pa	> 5			
Electrical power consumption at partial / full load (=values with integrated precipitator)	W	76 / 149 (175 / 236)			
Electrical power consumption in standby	W	15			
Maximum permissible operating pressure	bar	3			
Temperature adjustment range	°C	70 – 90			
Maximum permissible operating temperature	°C	90			
Boiler class		5 according to EN 303-5			
Suitable fuels		Pellets EN ISO 17225-2-A1, ENplus-A1			
Electrical connection		230 V AC / 50 Hz / 16 A			

Subject to technical changes and errors

Complies with  
EU standards



Austrian Ecolabel



# Pelletsboiler ETA ePE-K 180 - 240 kW

- 1** Connection for safety valve, pressure gauge and bleed valve, R5/4"
- 2** Flow, 2" ball valve
- 3** Return, 2" ball valve

- 4** Filling and draining valve
- 5** Safety heat exchanger R1/2"

The boiler can optionally be supplied with the pellet module (pellet hopper with stoker) on either the left or the right side.

Optimum maintenance area. Fixed components (e.g. expansion tank, hot water tank) in this area may require more cleaning and maintenance. The dimensions marked with an asterisk symbol (\*) indicate the minimum dimensions for the maintenance area.







ePE-K Pellet boiler		180	199	220	240
Rated heat capacity	kW	53.9 - 179.9	59.9 - 199.9	65.9 - 219.9	71.9 - 239.9
Efficiency at partial/full load	%	94.3 / 94.4	95 / 94.9	95.8 / 95.4	96.5 / 95.8
Transport dimensions (boiler) W x D x H	mm	1076 x 2073 x 1970			
Weight of the boiler	kg	1982			
Weight of the pellet module	kg	200			
Water content	litres	434			
Available residual pump head (at $\Delta T = 20K$ ) for buffer operation	mWs	6.5	5.5	4	2.5
	m <sup>3</sup> /h	7.7	8.5	9.4	10.2
Pellet bin on boiler (net)	kg	220 kg (1078 kWh)			
Maximum distance to pellet store	m	20			
Ash box volume	litres	94			
Required flue draught Due to the factory-installed flue gas recirculation, a draught limiter is required ( $\leq 15$ Pa).	Pa	> 5			
Electrical power consumption at partial / full load (=values with integrated precipitator)	W	78 / 227 (358 / 487)			
Electrical power consumption in standby	W	17			
Maximum permissible operating pressure	bar	3			
Temperature adjustment range	°C	70 – 90			
Maximum permissible operating temperature	°C	90			
Boiler class		5 according to EN 303-5			
Suitable fuels		Pellets EN ISO 17225-2-A1, ENplus-A1			
Electrical connection		230 V AC / 50 Hz / 16 A			

Subject to technical changes and errors

Complies with EU standards  Austrian Ecolabel 

# NOTES

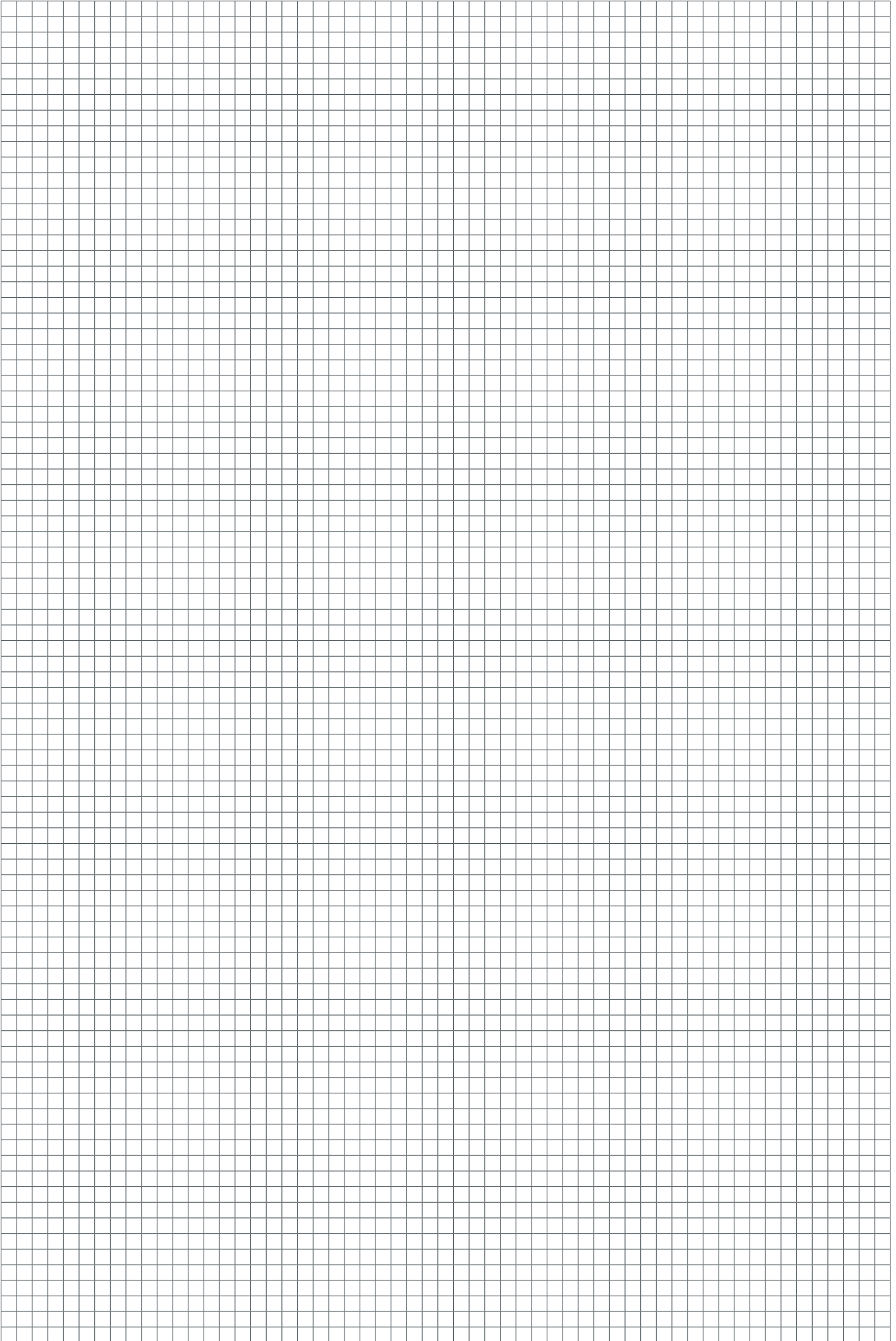

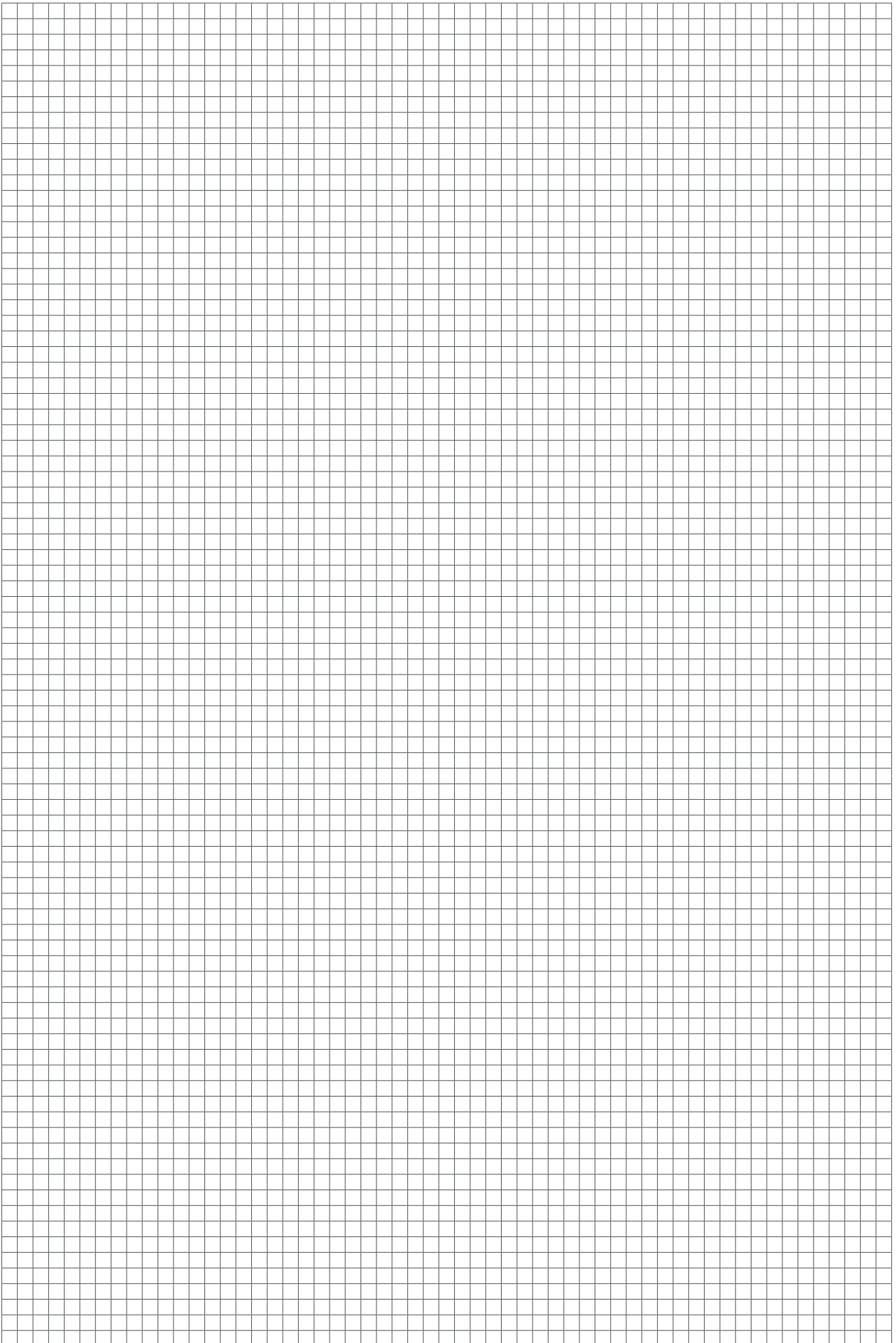



## ETA Pellets boiler

ETA PU PelletsUnit	7 - 15 kW
ETA ePE Pellets boiler	7 - 56 kW
ETA PC PelletsCompact	20 - 105 kW
ETA ePE-K Pellets boiler	100 - 240 kW



## ETA Condensing heat technology

ETA ePE BW Pellets boiler	8 - 62 kW
ETA BW Condensing heat exchanger PU	7 - 15 kW
ETA BW condensing heat exchanger PC	20 - 105 kW



## ETA SH Log wood boiler and TWIN Pellets boiler

ETA eSH Log wood boiler	16 - 40 kW
ETA eSH-TWIN Combination boiler with ETA eTWIN Pellets boiler	16 - 40 kW
ETA SH Log wood boiler	16 - 32 kW
ETA SH Log wood boiler	20 - 60 kW
ETA SH-P Log wood boiler with ETA TWIN Pellets boiler	20 - 60 kW
	20 - 50 kW



## ETA Wood chip boiler

ETA eHACK Wood chip boiler	20 - 240 kW
ETA HACK VR Wood chip boiler	250 - 500 kW

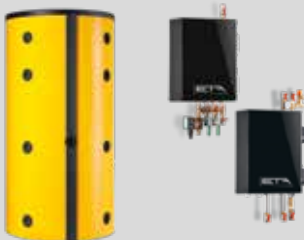

## ETA Buffer tank

ETA Buffer	500 l
ETA Buffer SP	600 - 5.000 l
ETA Buffer SPS	600 - 1.100 l

## ETA Hydraulic modules

ETA Fresh water module
ETA Stratified charging module
ETA System separation module
ETA Mixing circuit module
ETA Heat transfer module and station

Your heating specialist will be happy to advise you:



**ETA Heiztechnik GmbH**  
 Gewerbepark 1  
 A-4716 Hofkirchen an der Trattnach  
 Tel.: +43 7734 2288  
 Fax: +43 7734 2288-22  
 info@eta.co.at  
 www.eta.co.at

### Technical changes and mistakes reserved

In order to provide you the benefits of our continuous development, we reserve the right to change specifications without prior notice. Printing and typesetting errors or changes of any kind made in the interim are not cause for claims. Individual configurations depicted or described here are only available as options. In the event of discrepancies between individual documents regarding the scope of delivery, the information provided in our current price list shall prevail. Images and symbols may contain options that are available for an additional cost.

Photo source: ETA Heiztechnik GmbH, Lothar Prokop Photographie, istockphoto, Thinkstockphotos, Photocase, Shutterstock.  
 94702-EN, Prospekt Pelletskessel ETA ePE-K EN, 2025-02

